

User Manual

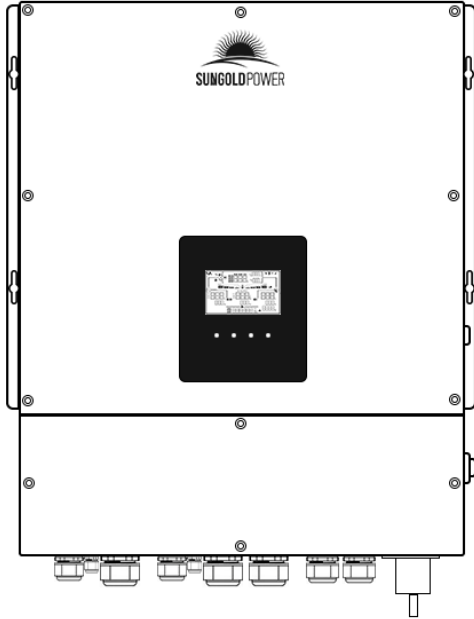

BluePower IP6048 Hybrid Inverter

Table Of Contents

1. Introduction	1
2. Important Safety Warning	2
3. Unpacking & Overview	4
3-1. Packing List	4
3-2. Product Overview	4
4. Installation	5
4-1. Precaution	5
4-2. Selecting Mounting Location	5
4.3. Mounting Unit	5
5. Grid (Utility) Connection	7
5-1. Preparation	7
5-2. Connecting to the AC Utility	7
6. Generator Connection	8
6-1. Preparation	8
6-2. Connecting to the Generator Input	8
7. PV Module (DC) Connection	9
8. Battery Connection	12
9. Load (AC Output) Connection	13
8-1. Preparation	13
8-2. Connecting to the AC output	13
9. Communication	15
9-1. Pin Assignment for RS-232 Communication Port	16
9-2. Pin Assignment for BMS Communication Port	16
9-3. Dry Contact Signal	16
10. Commissioning	18
11. Initial Setup	19
12. Operation	30
12-1. Interface	30
12-2. LCD Information Define	30
12-3. Touchable function keys	32
12-4. LCD Setting	33
12-5. Query Menu Operation	41
12-6. Operation Mode & Display	46
13. Charging Management	50
14. Maintenance & Cleaning	52
15. Trouble Shooting	53
15-1. Warning List	53
15-2. Fault Reference Codes	54
16. Specifications	56
Appendix I: Parallel Installation Guide	58
Appendix II: The Wi-Fi Operation Guide	65

1. Introduction

This hybrid PV inverter can provide power to connected loads by utilizing PV power, utility power and battery power.

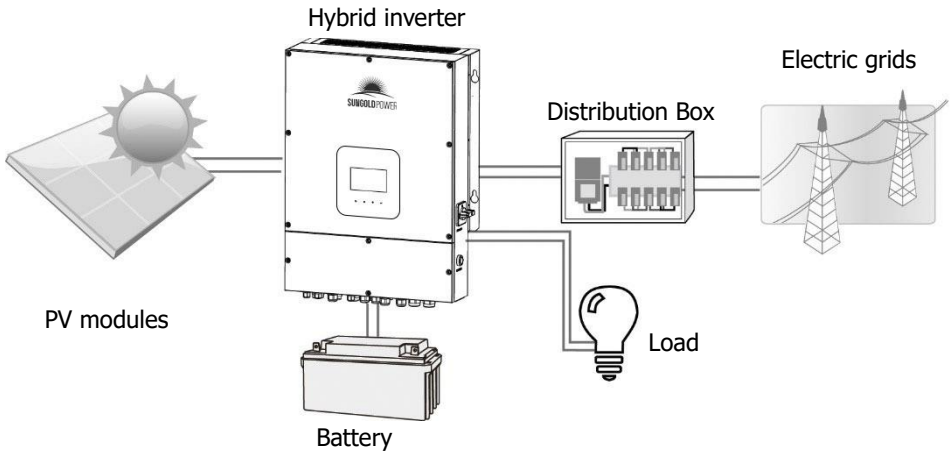

Figure 1 Basic hybrid PV System Overview

Depending on different power situations, this hybrid inverter is designed to generate continuous power from PV solar modules (solar panels), battery, and the utility. When MPP input voltage of PV modules is within acceptable range (see specification for the details), this inverter is able to generate power to feed the grid (utility) and charge battery. This inverter is only compatible with PV module types of single crystalline and poly crystalline. Do not connect any PV array types other than these two types of PV modules to the inverter. Do not connect the positive or negative terminal of the solar panel to the ground. See Figure 1 for a simple diagram of a typical solar system with this hybrid inverter.

2. Important Safety Warning

Before using the inverter, please read all instructions and cautionary markings on the unit and this manual. Store the manual where it can be accessed easily.

This manual is for qualified personnel. The tasks described in this manual may be performed by qualified personnel only.

General Precaution-

Conventions used:

WARNING! Warnings identify conditions or practices that could result in personal injury;

CAUTION! Caution identify conditions or practices that could result in damaged to the unit or other equipment connected.



WARNING! Before installing and using this inverter, read all instructions and cautionary markings on the inverter and all appropriate sections of this guide.



WARNING! Normally grounded conductors may be ungrounded and energized when a ground fault is indicated.



WARNING! This inverter is heavy. It should be lifted by at least two persons.



CAUTION! Authorized service personnel should reduce the risk of electrical shock by disconnecting AC, DC and battery power from the inverter before attempting any maintenance or cleaning or working on any circuits connected to the inverter. Turning off controls will not reduce this risk. Internal capacitors can remain charged for 5 minutes after disconnecting all sources of power.



CAUTION! Do not disassemble this inverter yourself. It contains no user-serviceable parts. Attempt to service this inverter yourself may cause a risk of electrical shock or fire and will void the warranty from the manufacturer.



CAUTION! To avoid a risk of fire and electric shock, make sure that existing wiring is in good condition and that the wire is not undersized. Do not operate the Inverter with damaged or substandard wiring.



CAUTION! Under high temperature environment, the cover of this inverter could be hot enough to cause skin burns if accidentally touched. Ensure that this inverter is away from normal traffic areas.



CAUTION! Use only recommended accessories from installer. Otherwise, not-qualified tools may cause a risk of fire, electric shock, or injury to persons.



CAUTION! To reduce risk of fire hazard, do not cover or obstruct the cooling fan.



CAUTION! Do not operate the Inverter if it has received a sharp blow, been dropped, or otherwise damaged in any way. If the Inverter is damaged, please call for an RMA (Return Material Authorization).



CAUTION! AC breaker, DC switch and Battery circuit breaker are used as disconnect devices and these disconnect devices shall be easily accessible.

Before working on this circuit

- Isolate inverter/Uninterruptible Power System (UPS)
- Then check for Hazardous Voltage between all terminals including the protective earth.



Risk of Voltage Backfeed

Symbols used in Equipment Markings

	Refer to the operating instructions
	Caution! Risk of danger
	Caution! Risk of electric shock
	Caution! Risk of electric shock. Energy storage timed discharge for 5 minutes.
	Caution! Hot surface

3. Unpacking & Overview

3-1. Packing List

Before installation, please inspect the unit. Be sure that nothing inside the package is damaged. You should have received the following items inside of package:

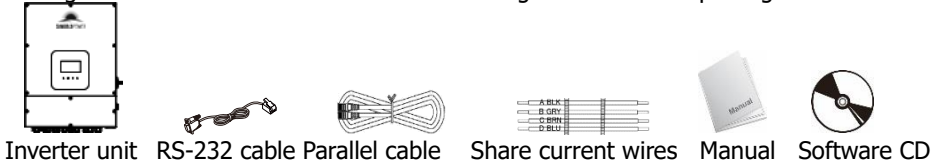

3-2. Product Overview

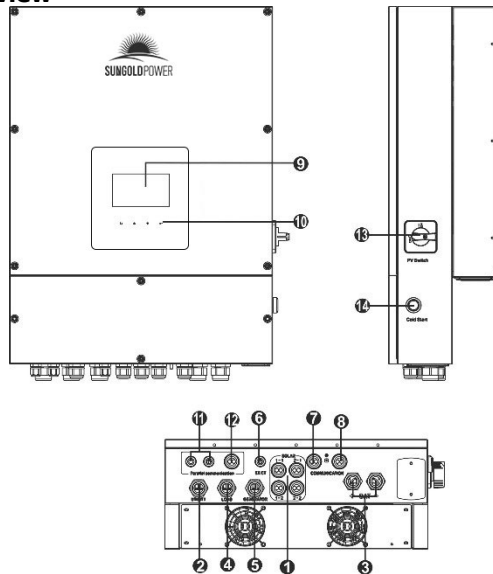

- | | |
|---|---|
| 1) PV connectors | 8) BMS & RS-232 communication port |
| 2) AC Grid connectors | 9) LCD display panel (Please check section 10 for detailed LCD operation) |
| 3) Battery connectors | 10) Operation buttons |
| 4) AC output connectors (Load connection) | 11) Current sharing port |
| 5) Generator input / Programmable load output | 12) Parallel communication port |
| 6) External sensor port (reserved) | 13) PV switch |
| 7) Dry contact & USB communication port | 14) Cold start button |

4. Installation

4-1. Precaution

This hybrid inverter is designed for indoor or outdoor use (IP65), please make sure the installation site meets below conditions:

- Not in direct sunlight
- Not in areas where highly flammable materials are stored.
- Not in potential explosive areas.
- Not in the cool air directly.
- Not near the television Antenna or antenna cable.
- Not higher than altitude of about 2000 meters above sea level.
- Not in environment of precipitation or humidity (>95%).

Please AVOID direct sunlight, rain exposure, snow laying up during installation and operation.

4-2. Selecting Mounting Location

- Please select a vertical wall with load-bearing capacity for installation, appropriate for installation on concrete or other non-flammable surfaces.
- The ambient temperature should be between -25~60°C to ensure optimal operation.
- Be sure to keep other objects and surfaces as shown in the diagram to guarantee sufficient heat dissipation and have enough space for removing wires.
- For proper air ventilation to dissipate heat, allow a clearance of approx. 50cm to the side and approx. 50cm above and below the unit. And 100cm toward the front.

4.3. Mounting Unit

WARNING!! Remember that this inverter is heavy! Please be carefully when lifting out from the package.

Installation to the wall should be implemented with the proper screws. After that, the device should be bolted on securely.

The inverter only can be used in a CLOSED ELECTRICAL OPERATING AREA. Only service person can enter into this area.

WARNING!! FIRE HAZARD.
SUITABLE FOR MOUNTING ON CONCRETE OR OTHER NON-COMBUSTIBLE SURFACE ONLY.

1. Fix four screws as shown in the chart. The reference tightening torque is 35 N.m.

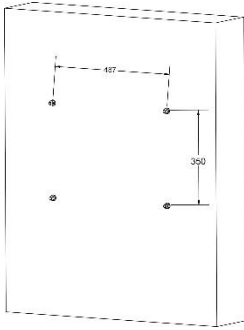

2. Raise the inverter and place it over the four screws.

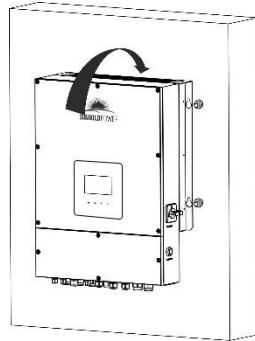

3. Check if the inverter is firmly secured.

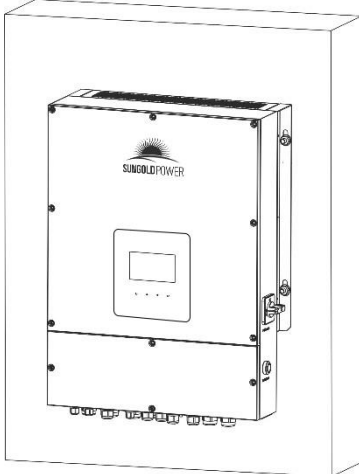

5. Grid (Utility) Connection

5-1. Preparation

NOTE 1: The overvoltage category of the AC input is III. It should be connected to the power distribution.

NOTE 2: Before connecting to grid, please install a separate AC breaker between inverter and grid. This will ensure the inverter can be securely disconnected during maintenance and fully protected from over current. The recommended of AC breaker is 40A/300V.

WARNING! It's very important for system safety and efficient operation to use appropriate cable for grid (utility) connection. To reduce risk of injury, please use the proper recommended cable size as below.

Suggested cable requirement for AC wire

Nominal Grid Voltage	120VAC per phase
Conductor cross-section (mm ²)	10-16
AWG no.	8-6

5-2. Connecting to the AC Utility

Please follow below steps to implement AC input connection:

1. Before making AC input connection, be sure to open DC protector or disconnector first.
2. Remove insulation sleeve 7mm for four conductors.
3. Insert AC input wires according to polarities indicated on terminal block and tighten the terminal screws. Be sure to connect PE protective conductor (⊕) first.

⊕ → **Ground (yellow-green)**

L1 → **LINE (black)**

L2 → **LINE (brown)**

N → **Neutral (blue)**

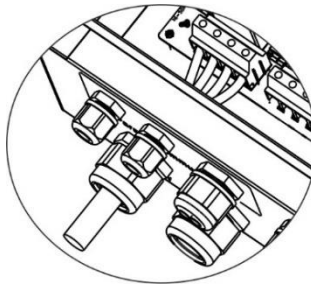

WARNING:

Be sure that AC power source is disconnected before attempting to hardwire it to the unit.

6. Generator Connection

There are two functions with this port:

- Allows generator input as power source
- Allows second AC output connect. This output can be turned On or Off by setting battery voltage.

6-1. Preparation

NOTE 1: The overvoltage category of the AC input is III. It should be connected to the power distribution.

NOTE 2: Before connecting to grid, please install a separate AC breaker between inverter and grid. This will ensure the inverter can be securely disconnected during maintenance and fully protected from over current. The recommended of AC breaker is 40A/300V.

WARNING! It's very important for system safety and efficient operation to use appropriate cable for generator connection. To reduce risk of injury, please use the proper recommended cable size as below.

Suggested cable requirement

Nominal Grid Voltage	120VAC per phase
Conductor cross-section (mm ²)	10-16
AWG no.	8-6

6-2. Connecting to the Generator Input

Please follow below steps to implement generator input connection:

1. Before making generator input connection, be sure to open DC protector or disconnecter first.
2. Remove insulation sleeve 7mm for four conductors.
3. Insert input wires according to polarities indicated on terminal block and tighten the terminal screws. Be sure to connect PE protective conductor (⊕) first.



→ **Ground (yellow-green)**

L1→ **LINE (black)**

L2→ **LINE (brown)**

N→ **Neutral (blue)**

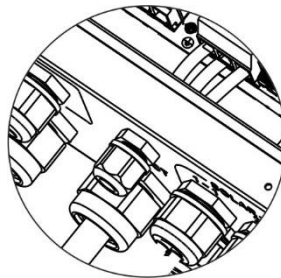

WARNING:

Be sure that generator power source is disconnected before attempting to hardwire it to the unit.

7. PV Module (DC) Connection

CAUTION: Before connecting to PV modules, please install **separately** a DC circuit breaker between inverter and PV modules.

NOTE1: Please use 1000VDC/20A circuit breaker.

NOTE2: The overvoltage category of the PV input is II.

Please follow below steps to implement PV module connection:

WARNING: Because this inverter is non-isolated, only **two** types of PV modules are acceptable: single crystalline and poly crystalline with class A-rated.
To avoid any malfunction, do not connect any PV modules with possibility of leakage current to the inverter. For example, grounded PV modules will cause leakage current to the inverter.

CAUTION: It's requested to have PV junction box with surge protection. Otherwise, it will cause inverter damage when lightning occurs on PV modules.

Step 1: Check the input voltage of PV array modules. The acceptable input voltage of the inverter is 120VDC - 600VDC. This system is applied with two strings of PV array. Please make sure that the maximum current load of each PV input connector is 15A.

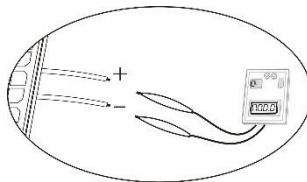

CAUTION: Exceeding the maximum input voltage can destroy the unit!! Check the system before wire connection.

Step 2: Disconnect the circuit breaker and switch off the DC switch.

Step 3: Remove insulation sleeve 7 mm for positive and negative conductors.

Step 4: Check correct polarity of connection cable from PV modules and PV input connectors. Then, connect positive pole (+) of connection cable to positive pole (+) of PV input connector. Connect negative pole (-) of connection cable to negative pole (-) of PV input connector.

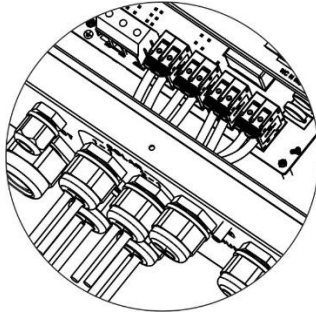

WARNING! It's very important for system safety and efficient operation to use appropriate cable for PV module connection. To reduce risk of injury, please use the proper recommended cable size as below.

Conductor cross-section (mm ²)	AWG no.
4	12

CAUTION: Never directly touch terminals of the inverter. It will cause lethal electric

CAUTION: Do NOT touch the inverter to avoid electric shock. When PV modules are exposed to sunlight, it may generate DC voltage to the inverter.

Recommended Panel Configuration

Specifications	Solar panel			
Nominal Max. Power (Pmax) (W)	430	455	520	535
Opt. Operating Voltage (Vmp) (V)	40.3	41.3	41.6	41.9
Opt. Operating Current (Imp) (A)	10.68	11.02	12.5	12.77
Open Circuit Voltage (Voc) (V)	48.3	49.3	49.14	49.44
Short Circuit Current (Isc) (A)	11.37	11.66	13.23	13.5
For 7.5KW input recommendation				
Numbers in series of MPPT1	12	11	11	10
Numbers of strings in MPPT1	1	1	1	1
Maximum input voltage of MPPT1 (V)	579.6	542.3	540.54	494.4
Input power of MPPT1 (W)	5160	5005	5720	5350
Numbers in series of MPPT2	6	6	4	5
Numbers of strings in MPPT2	1	1	1	1
Maximum input voltage of MPPT1 (V)	289.8	295.8	196.56	247.2
Input power of MPPT2 (W)	2580	2730	2080	2675
Total input power (W)	7740	7735	7800	8025
Minimum input recommendation				
Numbers in series of MPPT1	5	5	5	5
Numbers of strings in MPPT1	1	1	1	1
Maximum input voltage of MPPT1 (V)	241.5	246.5	245.7	247.2
Input power of MPPT1 (W)	2150	2275	2600	2675
Numbers in series of MPPT2	5	5	5	5
Numbers of strings in MPPT2	1	1	1	1
Maximum input voltage of MPPT1 (V)	241.5	246.5	245.7	247.2
Input power of MPPT2 (W)	2150	2275	2600	2675
Total input power (W)	4300	4550	5200	5350

8. Battery Connection

CAUTION: Before connecting to batteries, please install **separately** a DC circuit breaker between inverter and batteries.

NOTE1: Please only use sealed lead acid battery, vented and Gel battery. Please check maximum charging voltage and current when first using this inverter. If using Lithium iron or Nicd battery, please consult with installer for the details.

NOTE2: Please use 60VDC/200A circuit breaker.

NOTE3: The overvoltage category of the battery input is II.

Please follow below steps to implement battery connection:

Step 1: Check the nominal voltage of batteries. The nominal input voltage for inverter is 48VDC.

Step 2: Use two battery cables. Remove insulation sleeve 10 mm and insert conductor into cable ring terminal. Refer to right chart.

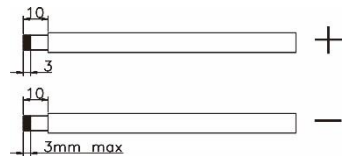

The cable size of each inverter is shown as below:

Recommended battery cable and terminal size for each inverter:

Wire Size	Ring Terminal			Torque value
	Cable mm ²	Dimensions		
		D (mm)	L (mm)	
3/0	85	8.4	54.2	7~12 Nm

WARNING: Be sure the length of all battery cables is the same. Otherwise, there will be voltage difference between inverter and battery to cause parallel inverters not working.

Step 3: Insert battery wires according to polarities indicated on the terminal block and tighten the terminal screws. Make sure polarity at both the battery and the inverter/charge is correctly connected.

RED cable to the positive terminal (+);

BLACK cable to the negative terminal (-).

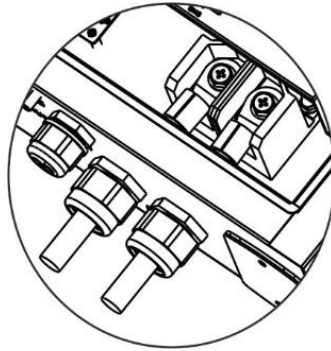

WARNING! Wrong connections will damage the unit permanently.

Step 4: Make sure the wires are securely connected. The reference tightening torque is 5.5~7.0 N.m.

WARNING! It's very important for system safety and efficient operation to use appropriate cable for battery connection. To reduce risk of injury, please use the proper recommended cable size as below.

Nominal Battery Voltage	48V
Conductor cross-section (mm ²)	85
AWG no.	3/0
Protective earthing (battery side)	150mm ² (300kcmil)

9. Load (AC Output) Connection

8-1. Preparation

CAUTION: To prevent further supply to the load via the inverter during any mode of operation, an additional disconnection device should be placed on in the building wiring installation.

WARNING! It's very important for system safety and efficient operation to use appropriate cable for AC connection. To reduce risk of injury, please use the proper recommended cable size as below.

Nominal Grid Voltage	120/208/240 VAC
Conductor cross-section (mm ²)	5.5-10
AWG no.	10-8

8-2. Connecting to the AC output

Step 1: Before making output connection, be sure to open DC protector or disconnector first.

Step 2: Remove insulation sleeve 7mm for four conductors.

Step 3: Insert AC input wires according to polarities indicated on terminal block and tighten the terminal screws. Be sure to connect PE protective conductor (⊕) first.

⊕ → **Ground (yellow-green)**

L1 → **LINE (black)**

L2 → **LINE (brown)**

N → **Neutral (blue)**

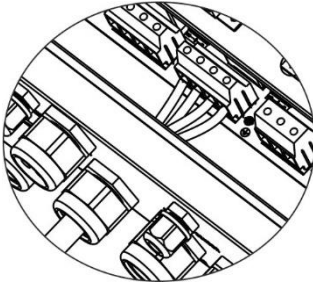

The reference tightening torque is 1.0-1.5 N.m.

Step 4: Make sure the wires are securely connected.

CAUTION: Do NOT connect the utility to "AC Output Connector (Load connector)".

CAUTION: Be sure to connect L terminal of load to L terminal of "AC Output Connector(Load connector)" and N terminal of load to N terminal of "AC Output Connector(Load connector)". The G terminal of "AC Output Connector" is connected to grounding of the load. Do NOT mis-connect.

CAUTION: Appliances such as air conditioner are required at least 2~3 minutes to restart because it's required to have enough time to balance refrigerant gas inside of circuits. If a power shortage occurs and recovers in a short time, it will cause damage to your connected appliances. To prevent this kind of damage, please check manufacturer of air conditioner if it's equipped with time-delay function before installation. Otherwise, this inverter/charger will trig overload fault and cut off output to protect your appliance but sometimes it still causes internal damage to the air conditioner.

9. Communication

The inverter is equipped with several communication ports and it is also equipped with a slot for alternative communication interfaces in order to communicate with a PC with corresponding software. Follow below procedure to connect communication wiring and install the software.

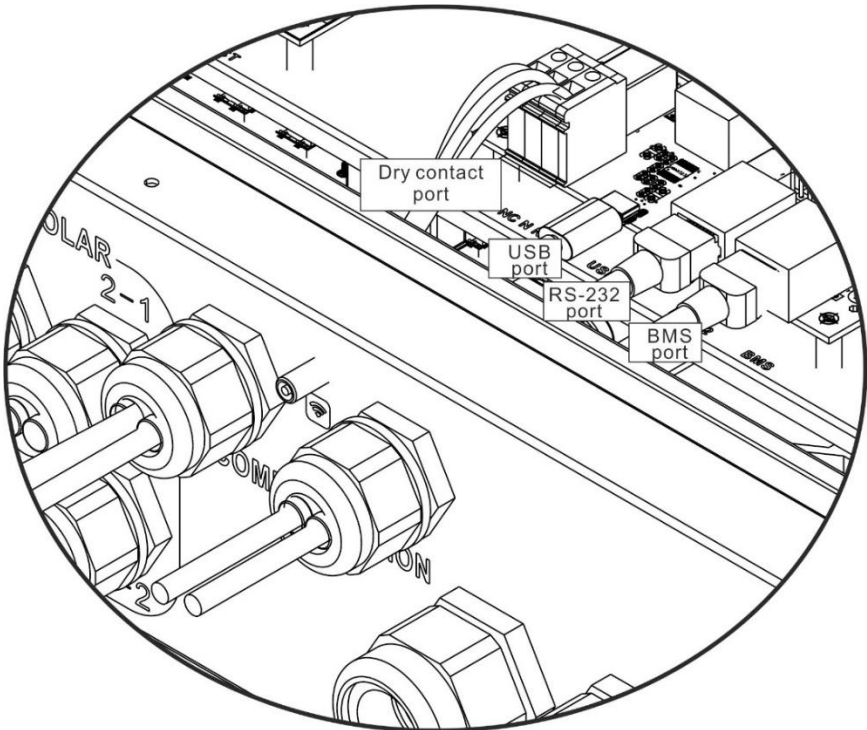

Please install monitoring software in your computer. Detailed information is listed in the next chapter. After software is installed, you may initial the monitoring software and extract data through communication port.

Wi-Fi Connection

This unit is equipped with a Wi-Fi transmitter. Wi-Fi transmitter can enable wireless communication between off-grid inverters and monitoring platform. Users can access and control the monitored inverter with downloaded APP. You may find "SolarPower Wi-Fi" app from the Apple® Store or "SolarPower" in Google® Play Store. All data loggers and parameters are saved in iCloud. For quick installation and operation, please refer to Appendix II - The Wi-Fi Operation Guide for details.

9-1. Pin Assignment for Communication Port

	Definition
PIN 1	NC
PIN 2	NC
PIN 3	NC
PIN 4	8~12V
PIN 5	NC
PIN 6	NC
PIN 7	NC
PIN 8	GND

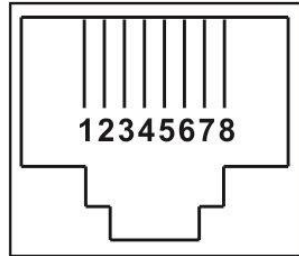
**9-2. Pin Assignment for BMS Communication Port**

	Definition
PIN 1	NC
PIN 2	NC
PIN 3	NC
PIN 4	NC
PIN 5	RS485A
PIN 6	CANH
PIN 7	CANL
PIN 8	GND

9-3. Dry Contact Signal

There is one dry contact available on the bottom panel. It could be used to remote control for external generator.

Electric Parameter

Parameter	Symbol	Max.	Unit
Relay DC voltage	Vdc	30	V
Relay DC current	Idc	1	A

Note: The application of the dry contact should not exceed the electric parameter shown as above. Otherwise, the internal relay will be damaged.

Function Description

Unit Status	Condition	 Dry contact port: NC C NO	
		NO&C	NC&C
Power Off	Unit is off and no output is powered.	Open	Close
Power On	Battery voltage is lower than setting battery cut-off discharging voltage when grid is available.	Close	Open
	Battery voltage is lower than setting battery cut-off discharging voltage when grid is unavailable.	Close	Open
	Battery voltage is higher than below 2 setting values: 1. Battery re-discharging voltage when grid is available. 2. Battery re-discharging voltage when grid unavailable.	Open	Close

You can set the related parameters in software. Refer to below chart:

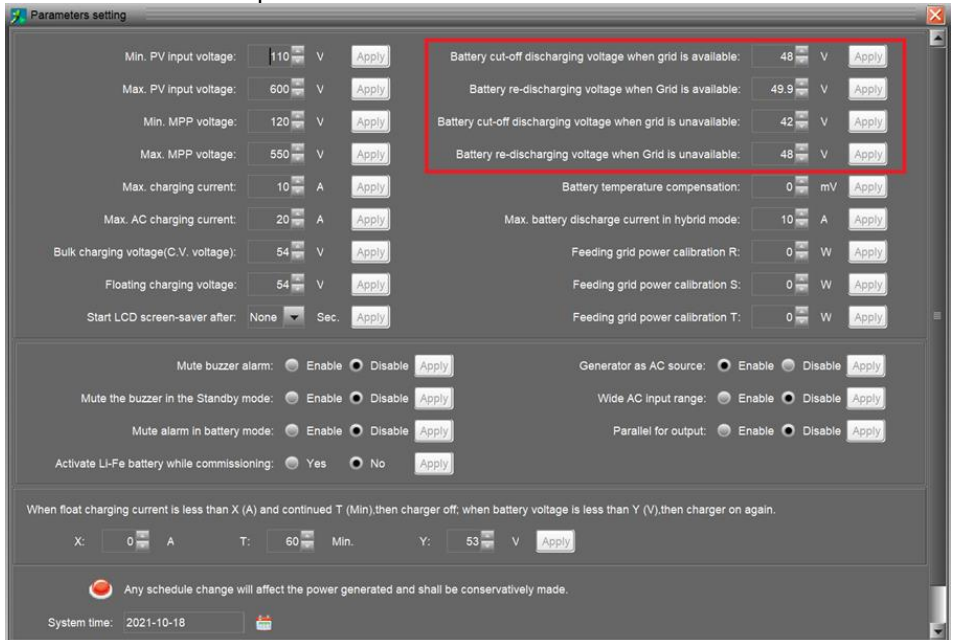

Parameters setting

Min. PV input voltage: 110 V Apply

Max. PV input voltage: 600 V Apply

Min. MPP voltage: 120 V Apply

Max. MPP voltage: 550 V Apply

Max. charging current: 10 A Apply

Max. AC charging current: 20 A Apply

Bulk charging voltage(C.V. voltage): 54 V Apply

Floating charging voltage: 54 V Apply

Start LCD screen-saver after: None Sec. Apply

Battery cut-off discharging voltage when grid is available: 48 V Apply

Battery re-discharging voltage when Grid is available: 49.9 V Apply

Battery cut-off discharging voltage when grid is unavailable: 42 V Apply

Battery re-discharging voltage when Grid is unavailable: 48 V Apply

Battery temperature compensation: 0 mV Apply

Max. battery discharge current in hybrid mode: 10 A Apply

Feeding grid power calibration R: 0 W Apply

Feeding grid power calibration S: 0 W Apply

Feeding grid power calibration T: 0 W Apply

Mute buzzer alarm: Enable Disable Apply

Mute the buzzer in the Standby mode: Enable Disable Apply

Mute alarm in battery mode: Enable Disable Apply

Activate Li-Fe battery while commissioning: Yes No Apply

Generator as AC source: Enable Disable Apply

Wide AC input range: Enable Disable Apply

Parallel for output: Enable Disable Apply

When float charging current is less than X (A) and continued T (Min),then charger off; when battery voltage is less than Y (V),then charger on again.

X: 0 A T: 60 Min. Y: 53 V Apply

Any schedule change will affect the power generated and shall be conservatively made.

System time: 2021-10-18

10. Commissioning

Step 1: Check the following requirements before commissioning:

- Ensure the inverter is firmly secured
- Check if the open circuit DC voltage of PV module meets requirement (Refer to Section 6)
- Check if the open circuit utility voltage of the utility is at approximately same to the nominal expected value from local utility company.
- Check if connection of AC cable to grid (utility) is correct if the utility is required.
- Full connection to PV modules.
- AC circuit breaker (only applied when the utility is required), batter circuit breaker, and DC circuit breaker are installed correctly.

Step 2: Switch on the battery circuit breaker and then switch on PV DC breaker. After that, if there is utility connection, please switch on the AC circuit breaker. At this moment, the inverter is turned on already. However, there is no output generation for loads. Then:

- If LCD lights up to display the current inverter status, commissioning has been successfully. After pressing "ON" button for 1 second when the utility is detected, this inverter will start to supply power to the loads. If no utility exists, simply press "ON" button for 3 seconds. Then, this inverter will start to supply power to the loads.
- If a warning/fault indicator appears in LCD, an error has occurred to this inverter. Please inform your installer.

Step 3: Please insert CD into your computer and install monitoring software in your PC. Follow below steps to install software.

1. Follow the on-screen instructions to install the software.
2. When your computer restarts, the monitoring software will appear as shortcut icon located in the system tray, near the clock.

11. Initial Setup

Before inverter operation, it's required to set up "Operation Mode" via software. Please strictly follow below steps to set up. For more details, please check software manual.

Step 1: After turning on the inverter and installing the software, please click "Open Monitor" to enter main screen of this software.

Step 2: Log in into software first by entering default password "administrator".

Step 3: Select Device Control>>MyPower Management. It is to set up inverter operation mode and personalized interface. Refer to diagram below.

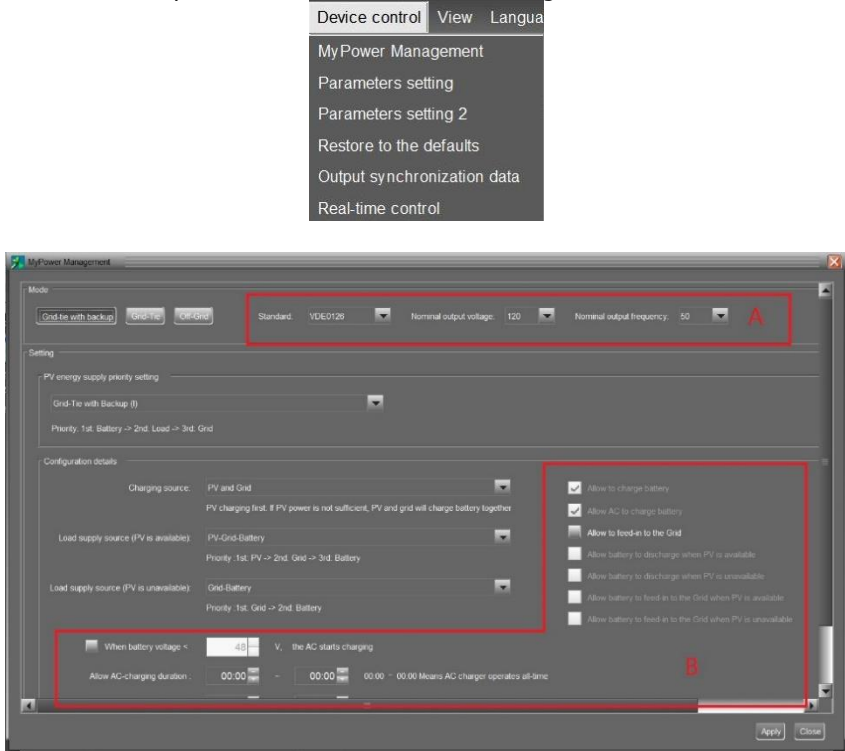

Mode

There are three operation modes: Grid-tie with backup, Grid-Tie and Off-Grid.

- Grid-tie with backup: PV power can feed-in back to grid, provide power to the load and charge battery. There are four options available in this mode: Grid-tie with backup I, II, III and IV. In this mode, users can configure PV power supply priority, charging source priority and load supply source priority. However, when Grid-tie with backup IV option is selected in PV energy supply priority, the inverter is only operated between two working logics based on defined peak time and off-peak time of electricity. Only peak time and off-peak time of electricity are able to set up for optimized electricity usage.

- Grid-Tie: PV power only can feed-in back to grid.
- Off-Grid: PV power only provides power to the load and charge battery. No feed-in back to grid is allowed.

SECTION A:

Standard: It will list local grid standard. It’s requested to have factory password to make any modifications. Please check local dealer only when this standard change is requested.

CAUTION: Wrong setting could cause the unit damage or not working.

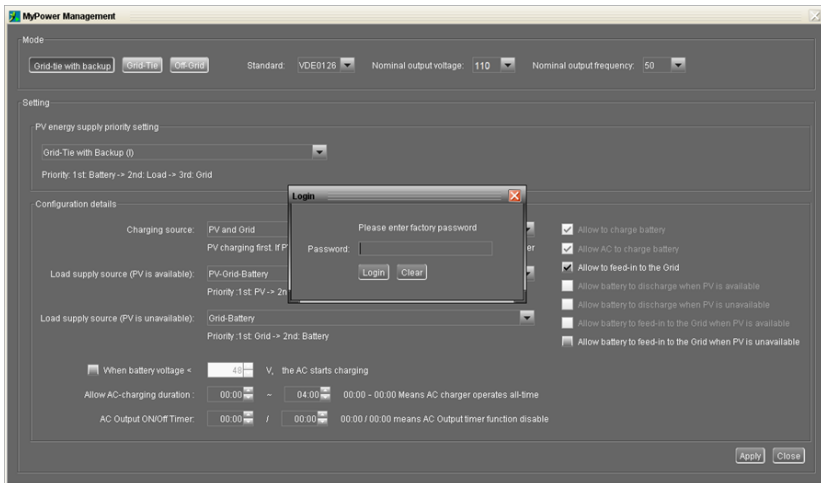

Nominal Output Voltage: 120V.

Nominal Output Frequency: 60Hz.

SECTION B:

This section contents may be different based on different selected types of operations.

Allow AC charging duration: It’s a period time to allow AC (grid) to charge battery. When the duration is set up as 0:00-00:00, it means no time limitation for AC to charge battery.

AC output ON/Off Timer: Set up on/off time for AC output of inverter. If setting it as 00:00/00:00, this function is disabled.

Allow to charge battery: This option is automatically determined by setting in "Charging source". It’s not allowed to modify here. When "NONE" is selected in charging source section, this option becomes unchecked as grey text.

Allow AC to charge battery: This option is automatically determined by setting in "Charging source". It’s not allowed to modify here. When "Grid and PV" or "Grid

or PV" is selected in charging source section, this option is default selected. Under Grid-tie mode, this option is invalid.

Allow to feed-in to the Grid: This option is only valid under Grid-tie and Grid-tie with backup modes. Users can decide if this inverter can feed-in to the grid.

Allow battery to discharge when PV is available: This option is automatically determined by setting in "Load supply source (PV is available)". When "Battery" is higher priority than "Grid" in Load supply source (PV is available), this option is default selected. Under Grid-tie, this option is invalid.

Allow battery to discharge when PV is unavailable: This option is automatically determined by setting in "Load supply source (PV is unavailable)". When "Battery" is higher priority than "Grid" in Load supply source (PV is unavailable), this option is default selected. Under Grid-tie mode, this option is invalid.

Allow battery to feed-in to the Grid when PV is available: This option is only valid in Grid-tie with backup II or Grid-tie with backup III modes.

Allow battery to feed-in to the Grid when PV is unavailable: This option is only valid in all options of Grid-tie with backup mode.

Grid-tie with backup

- Grid-tie with backup (I) :

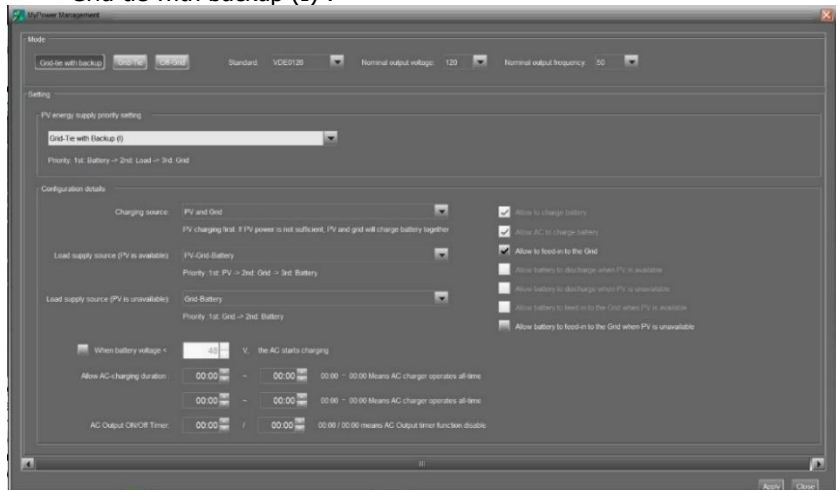

PV energy supply priority setting: 1st Battery, 2nd Load and 3rd Grid.

PV power will charge battery first, then provide power to the load. If there is any remaining power left, it will feed-in to the grid.

Battery charging source:

1. PV and Grid (Default)

It's allowed to charge battery from PV power first. If it's not sufficient, grid will charge battery.

2. PV only

It is only allow PV power to charge battery.

3. None

It is not allowed to charge battery no matter it's from PV power or grid.

Load supply source:

When PV power is available: 1st PV, 2nd Grid, 3rd Battery

If battery is not fully charged, PV power will charge battery first. And remaining PV power will provide power to the load. If it's not sufficient, grid will provide power to the load. If grid is not available at the same time, battery power will back up.

When PV power is not available:

1. 1st Grid, 2nd Battery (Default)

Grid will provide power to the load at first. If grid is not available, battery power will provide power backup.

2. 1st Battery, 2nd Grid

Battery power will provide power to the load at first. If battery power is running out, grid will back up the load.

NOTE: This option will become ineffective during AC charging time and the priority will automatically become 1st Grid and 2nd Battery order. Otherwise, it will cause battery damage.

● **Grid-tie with backup (II) :**

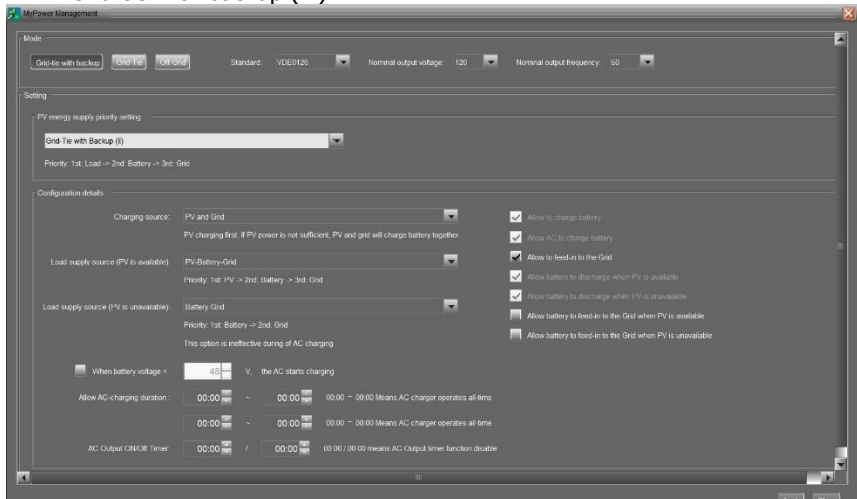

PV energy supply priority setting: 1st Load, 2nd Battery and 3rd Grid.

PV power will provide power to the load first. Then, it will charge battery. If there is any remaining power left, it will feed-in to the grid.

Battery charging source:

1. PV and Grid

It's allowed to charge battery from PV power first. If it's not sufficient, grid will charge battery.

2. PV only

It is only allow PV power to charge battery.

3. None

It is not allowed to charge battery no matter it's PV power or grid.

Load supply source:

When PV power is available:

1. 1st PV, 2nd Battery, 3rd Grid

PV power will provide power to the load first. If it's not sufficient, battery power will provide power to the load. When battery power is running out or not available, grid will back up the load.

2. 1st PV, 2nd Grid, 3rd Battery

PV power will provide power to the load first. If it's not sufficient, grid will provide power to the load. If grid is not available at the same time, battery power will back up.

When PV power is not available:

1. 1st Grid, 2nd Battery: Grid will provide power to the load at first. If grid is not available, battery power will provide power backup.

2. 1st Battery, 2nd Grid: Battery power will provide power to the load at first. If battery power is running out, grid will back up the load

NOTE: This option will become ineffective during AC charging time and the priority will automatically become 1st Grid and 2nd Battery order. Otherwise, it will cause battery damage.

● Grid-tie with backup (III):

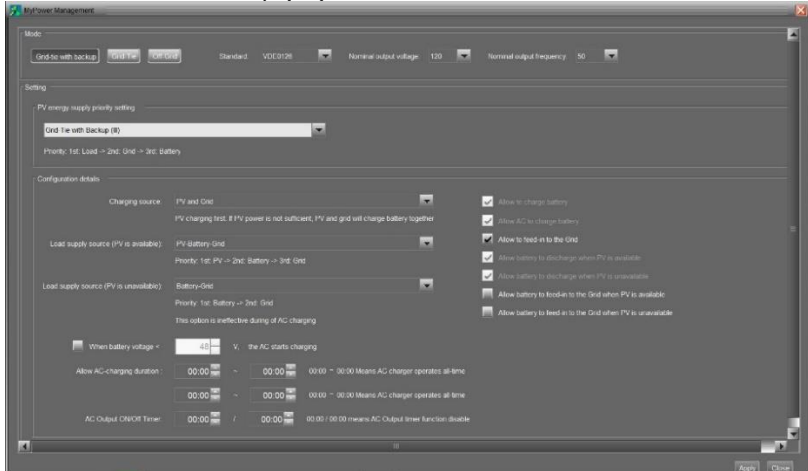

PV energy supply priority setting: 1st Load, 2nd Grid and 3rd Battery

PV power will provide power to the load first. If there is more PV power available, it will feed-in to the grid. If feed-in power reaches max. feed-in power setting, the remaining power will charge battery.

NOTE: The max. feed-in grid power setting is available in parameter setting. Please refer to software manual.

Battery charging source:

1. PV and Grid: It's allowed to charge battery from PV power first. If it's not sufficient, grid will charge battery.
2. PV only: It is only allow PV power to charge battery.
3. None: It is not allowed to charge battery no matter it's PV power or grid.

Load supply source:

When PV power is available:

1. 1st PV, 2nd Battery, 3rd Grid

PV power will provide power to the load first. If it's not sufficient, battery power will provide power to the load. When battery power is running out or not available, grid will back up the load.

2. 1st PV, 2nd Grid, 3rd Battery

PV power will provide power to the load first. If it's not sufficient, grid will provide power to the load. If grid is not available at the same time, battery power will back up.

When PV power is not available:

1. 1st Grid, 2nd Battery: Grid will provide power to the load at first. If grid is not available, battery power will provide power backup.
2. 1st Battery, 2nd Grid: Battery power will provide power to the load at first. If

battery power is running out, grid will back up the load.

NOTE: This option will become ineffective during AC charging time and the priority will automatically become 1st Grid and 2nd Battery order. Otherwise, it will cause battery damage.

- Grid-tie with backup (IV): Users are only allowed to set up peak time and off-peak electricity demand.

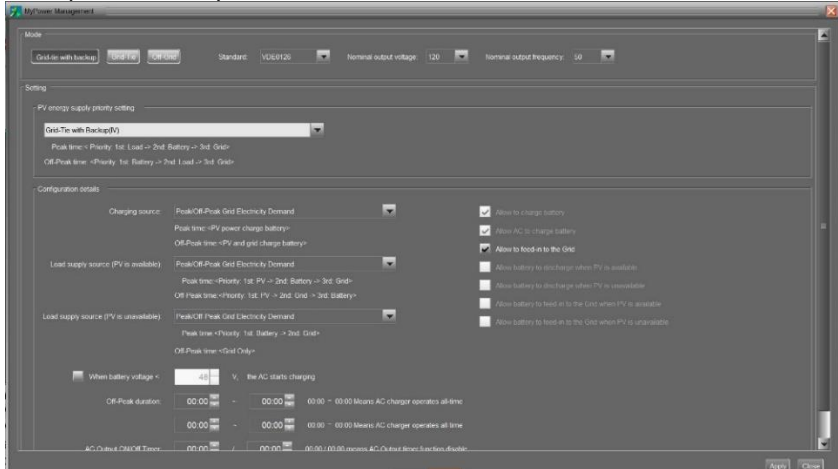

Working logic under peak time:

PV energy supply priority: 1st Load, 2nd Battery and 3rd Grid

PV power will provide power to the load first. If PV power is sufficient, it will charge battery next. If there is remaining PV power left, it will feed-in to the grid. Feed-in to the grid is default disabled.

Battery charging source: PV only

Only after PV power fully supports the load, the remaining PV power is allowed to charge battery during peak time.

Load supply source: 1st PV, 2nd Battery, 3rd Grid

PV power will provide power to the load first. If PV power is not sufficient, battery power will back up the load. If battery power is not available, grid will provide the load. When PV power is not available, battery power will supply the load first. If battery power is running out, grid will back up the load.

Working logic under off-peak time:

PV energy supply priority: 1st Battery, 2nd Load and 3rd Grid

PV power will charge battery first. If PV power is sufficient, it will provide power to the loads. The remaining PV power will feed to the grid.

NOTE: The max. feed-in grid power setting is available in parameter setting.

Please refer to software manual.

Battery charging source: PV and grid charge battery

PV power will charge battery first during off-peak time. If it's not sufficient, grid will charge battery.

Load supply source: 1st PV, 2nd Grid, 3rd Battery

When battery is fully charged, remaining PV power will provide power to the load first. If PV power is not sufficient, grid will back up the load. If grid power is not available, battery power will provide power to the load.

Grid-Tie

Under this operation mode, PV power only feeds-in to the grid. No priority setting is available.

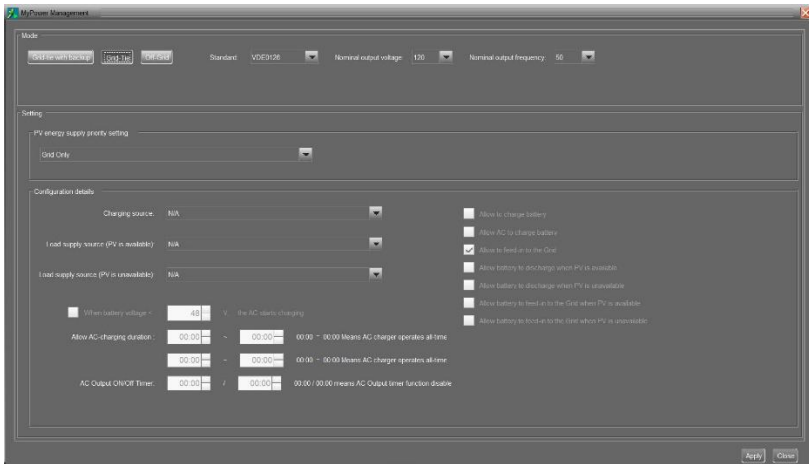

Off-Grid

● **Off-Grid (I): Default setting for off-grid mode.**

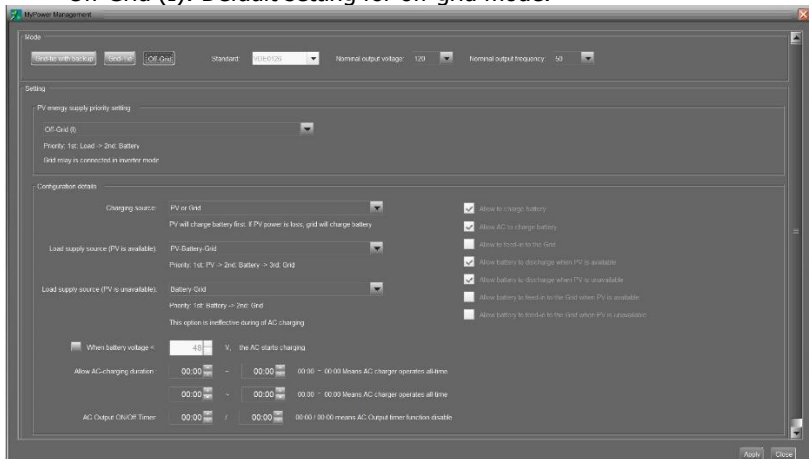

PV energy supply priority setting: 1st Load, 2nd Battery

PV power will provide power to the load first and then charge battery. Feed-in to the grid is not allowed under this mode. At the same time, the grid relay is connected in Inverter mode. That means the transfer time from inverter mode to battery mode will be less than 15ms. Besides, it will avoid overload fault because grid can supply load when connected load is over rated output capacity of the inverter.

Battery charging source:

1. PV or Grid: If there is remaining PV power after supporting the loads, it will charge battery first. Only until PV power is not available, grid will charge battery. (Default)
2. PV only: It is only allow PV power to charge battery.
3. None: It is not allowed to charge battery no matter it's PV power or grid.

Load supply source:

When PV power is available:

1. 1st PV, 2nd Battery, 3rd Grid (Default)

PV power will provide power to the load first. If it's not sufficient, battery power will provide power to the load. When battery power is running out or not available, grid will back up the load.

2. 1st PV, 2nd Grid, 3rd Battery

PV power will provide power to the load first. If it's not sufficient, grid will provide power to the load. If grid is not available at the same time, battery power will back up.

When PV power is not available:

1. 1st Grid, 2nd Battery

Grid will provide power to the load at first. If grid is not available, battery power will provide power backup.

2. 1st Battery, 2nd Grid (Default)

Battery power will provide power to the load at first. If battery power is running out, grid will back up the load.

NOTE: This option will become ineffective during AC charging time and the priority will automatically become 1st Grid and 2nd Battery order. Otherwise, it will cause battery damage.

● Off-Grid (II)

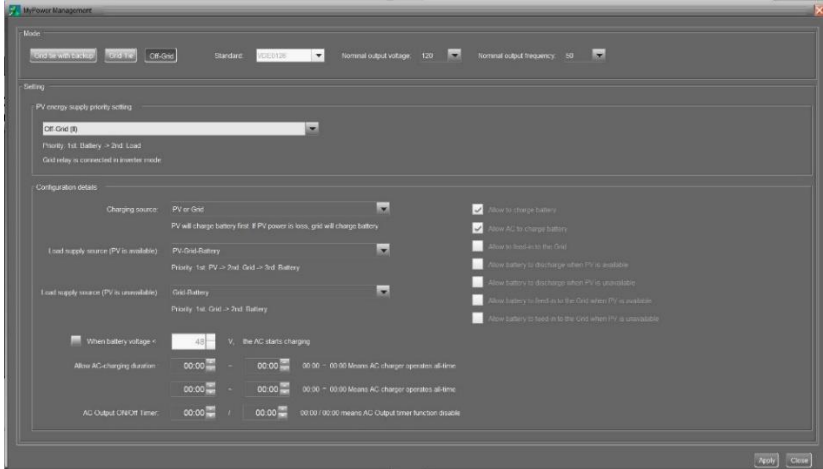

PV energy supply priority setting: 1st Battery, 2nd Load

PV power will charge battery first. After battery is fully charged, if there is remaining PV power left, it will provide power to the load. Feed-in to the grid is not allowed under this mode. At the same time, the grid relay is connected in Inverter mode. That means the transfer time from inverter mode to battery mode will be less than 15ms. Besides, it will avoid overload fault because grid can supply load when connected load is over rated output capacity of the inverter.

Battery charging source:

1. PV or Grid: If there is remaining PV power after supporting the loads, it will charge battery first. Only until PV power is not available, grid will charge battery.
2. PV only: It is only allow PV power to charge battery.
3. None: It is not allowed to charge battery no matter it's PV power or grid.

NOTE: It's allowed to set up AC charging duration.

Load supply source:

When PV power is available: 1st PV, 2nd Grid, 3rd Battery

PV power will provide power to the load first. If it's not sufficient, grid will provide power to the load. If grid is not available at the same time, battery power will back up.

When PV power is not available:

1. 1st Grid, 2nd Battery: Grid will provide power to the load at first. If grid is not available, battery power will provide power backup.
2. 1st Battery, 2nd Grid: Battery power will provide power to the load at first. If battery power is running out, grid will back up the load.

NOTE: This option will become ineffective during AC charging time and the priority will automatically become 1st Grid and 2nd Battery order. Otherwise, it will cause battery damage.

● Off-Grid (III)

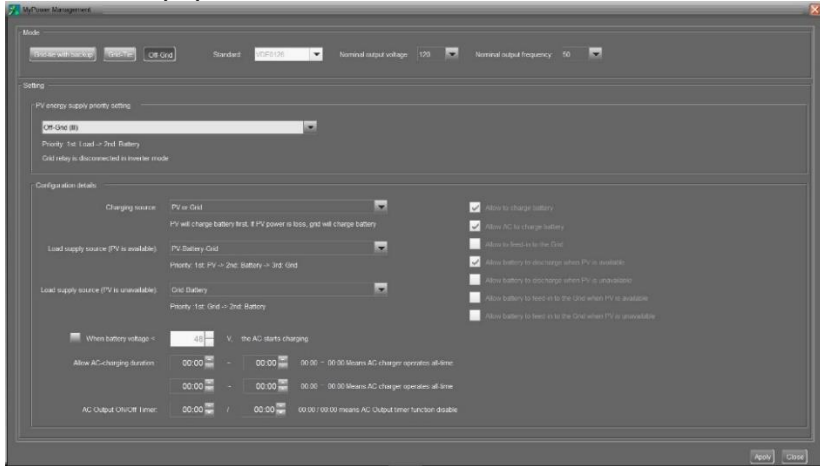

PV energy supply priority setting: 1st Load, 2nd Battery

PV power will provide power to load first and then charge battery. Feed-in to the grid is not allowed under this mode. The grid relay is NOT connected in Inverter mode. That means the transfer time from inverter mode to battery mode will be about 15ms. If connected load is over rated output capacity of the inverter and grid is available, this inverter will allow grid to provide power to the loads and PV power to charge battery. Otherwise, this inverter will activate fault protection.

Battery charging source:

1. PV or Grid: If there is remaining PV power after supporting the loads, it will charge battery first. Only until PV power is not available, grid will charge battery.
2. PV only: It is only allow PV power to charge battery.
3. None: It is not allowed to charge battery no matter it's PV power or grid.

NOTE: It's allowed to set up AC charging duration.

Load supply source:

When PV power is available: 1st PV, 2nd Battery, 3rd Grid

PV power will provide power to the load first. If it's not sufficient, battery power will back up the load. Only after battery power is running, Grid will back up the load.

When PV power is not available:

1. 1st Grid, 2nd Battery: Grid will provide power to the load at first. If grid is not available, battery power will provide power backup.
2. 1st Battery, 2nd Grid: Battery power will provide power to the load at first. If battery power is running out, grid will back up the load.

NOTE: This option will become ineffective during AC charging time and the priority will automatically become 1st Grid and 2nd Battery order. Otherwise, it will cause battery damage.

12. Operation

12-1. Interface



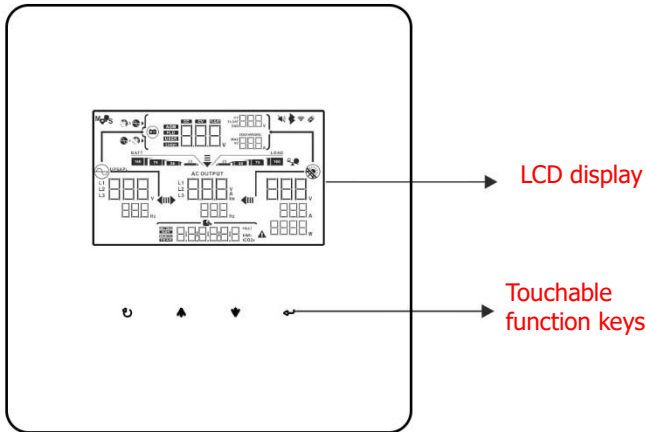





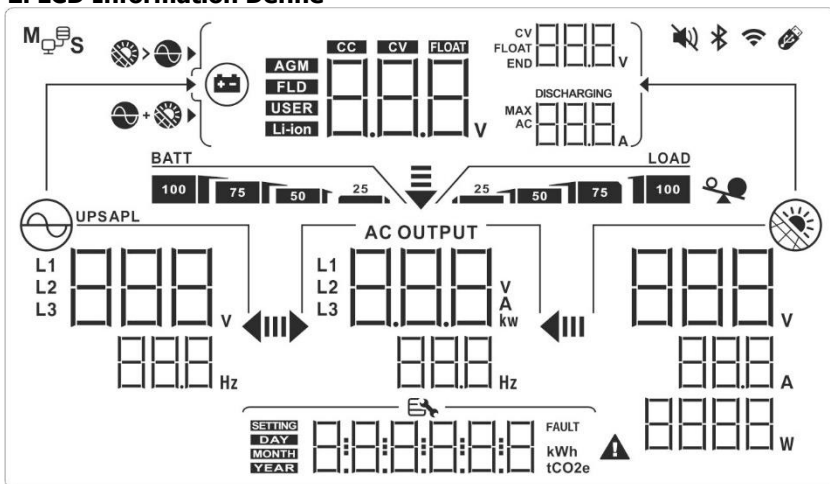

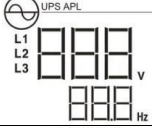
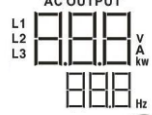
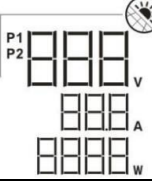
The operation LCD panel, shown in the chart below, includes four touchable function keys and a LCD display to indicate the operating status and input/output power information.

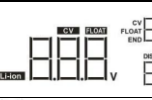



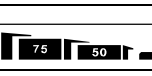

NOTICE: To accurately monitor and calculate the energy generation, please calibrate the timer of this unit via software every one month. For the detailed calibration, please check the user manual of bundled software.



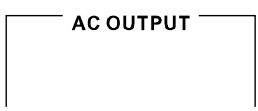

12-2. LCD Information Define



Display	Function
 <p>UPS APL L1 L2 L3 V Hz</p>	<p>Indicates AC input voltage and frequency. V: voltage, Hz: frequency, L1/L2/L3: Line phase</p>
 <p>AC OUTPUT L1 L2 L3 V A kw Hz</p>	<p>Indicates AC output power, voltage, frequency, or current. kw: active power, V: voltage, Hz: frequency, A: current L1/L2/L3: AC output phase</p>
 <p>P1 P2 V A W</p>	<p>Indicates PV input voltage, power or current. V: voltage, W: power, P1: PV input 1, P2: PV input 2 A: current</p>
	<p>Allow AC and PV charging</p>
	<p>Only PV charging is allowed</p>
 <p>BATT CV FLOAT FLOAT END V A CHARGING</p>	<p>Indicates battery voltage, battery current, charging status or battery parameters V: voltage, A: current, Li-ion: Lithium-ion battery type</p>
 <p>BATT 100 75 50 25</p>	<p>Indicates battery level in battery mode.</p>
 <p>FAULT</p>	<p>Indicates the warning and fault codes.</p>
 <p>DATE TIME MONTH YEAR kWh</p>	<p>Indicates date and time or the date and time users set for querying energy generation.</p>
	<p>Indicates solar panels. Icon flashing indicates PV input voltage is out of range.</p>
	<p>Indicates utility. Icon flashing indicates utility voltage or frequency is out of range.</p>
 <p>BATT 100 75 50 25</p>	<p>Indicates battery condition. And the lattice of the icon indicates battery capacity.</p>
 <p>BATT</p>	<p>Icon  flashing indicates battery is not allowed to discharge.</p>

	Icon  flashing indicates the battery voltage is too low.
	Indicates AC output for loads is enabled and inverter is providing power to the connected loads.
	Indicates AC output for loads is enabled but there is no power provided from inverter. At this time, no battery and the utility are available. Only PV power exists but is not able to provide power to the connected loads.
	Indicates overload.
	Indicates parallel operation is working.

12-3. Touchable function keys



Function Key		Operation	Function
	Enter/ON	Quick touch.	Enter query menu.
		Touch and hold the button for approximately 1 second when the utility is detected or 3 seconds without the utility.	If it's in query menu, touch this button to confirm selection or entry.
	ESC/OFF	Quick touch.	Return to previous menu.
Touch and hold the button until the buzzer continuously sounds.		Turn off power to the loads.	
	Up	Quick touch.	Select last selection or increase value.
	Down	Quick touch.	If it's in query menu, press this button to jump to next selection or decrease value.
			Mute alarm in standby mode or battery mode.
		Touch and hold these two buttons for 2 seconds.	Enter setting mode.





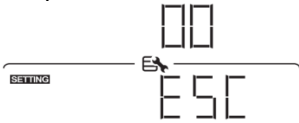
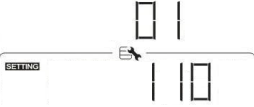
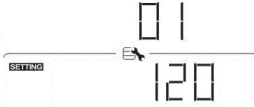
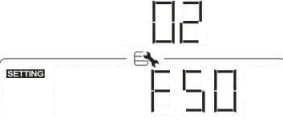
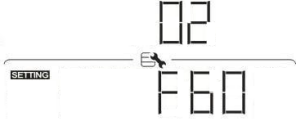
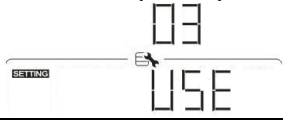
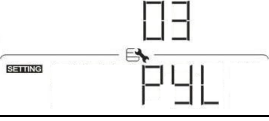
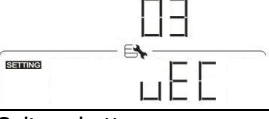
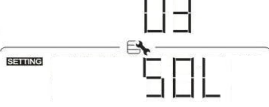

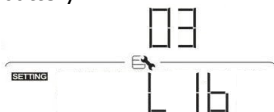
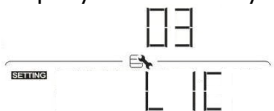
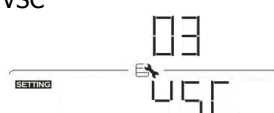
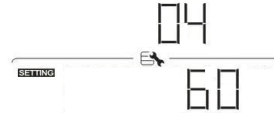

NOTE: If backlight shuts off, you may activate it by touching any button.

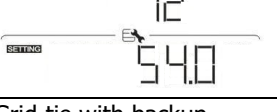

12-4. LCD Setting

After touching and holding "UP" and "DOWN" button for 2 seconds, the unit will enter setting mode. Press "UP" or "DOWN" button to select setting programs. And then, press "ENTER" button to confirm the selection or ESC button to exit.

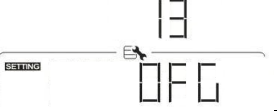

Prog ram	Description	Selectable option	
00	Exit setting mode	Escape 	
01	Output voltage	110Vac 	120Vac(default) 
02	Output frequency	50Hz(default) 	60Hz 
03	Battery type	User-Defined(default) 	If "User Defined" is selected, battery charge voltage and low DC cut off voltage can be set up in program 4, 7, 8 and 9.
		Pylontech battery 	If selected, programs of 4, 7, 8 and 9 will be automatically set up. No need for further setting.
		WECO battery 	If selected, programs of 4, 7, 8 and 9 will be auto-configured per battery supplier recommended. No need for further adjustment.
		Soltaro battery 	If selected, programs of 4, 7, 8 and 9 will be automatically set up. No need for further setting.

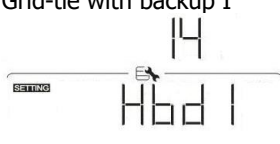
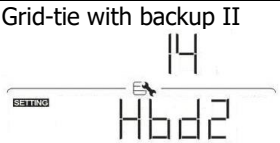
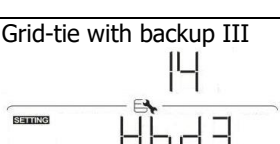
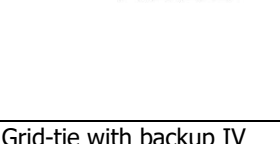

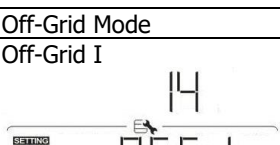



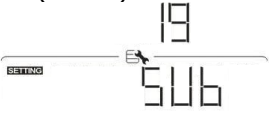
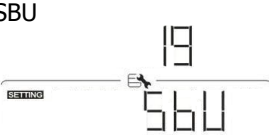
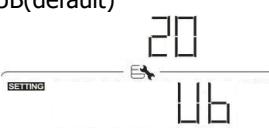
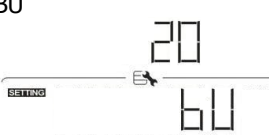
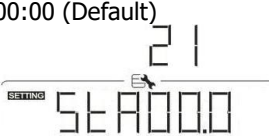
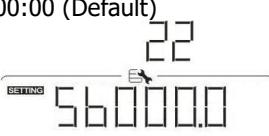

03	Battery type	<p>LiB-protocol compatible battery</p> 	<p>Select "LiB" if using Lithium battery compatible to Lib protocol. If selected, programs of 4, 7, 8 and 9 will be automatically set up. No need for further setting.</p>
		<p>3rd party Lithium battery</p> 	<p>If selected, programs of 4, 7, 8 and 9 will be automatically set up. No need for further setting. Please contact the battery supplier for installation procedure.</p>
		<p>VSC</p> 	<p>If selected, standard CAN protocol will be supported.</p>
04	<p>Maximum charging current: To configure total charging current for solar and utility chargers. (Max. charging current = utility charging current + solar charging current)</p>	<p>60A(default)</p> 	<p>Setting range is 1A, then from 10A to 120A. Increment of each click is 10A.</p>
05	<p>Maximum utility charging current</p>	<p>60A(default)</p> 	<p>Setting range is from 10A to 120A. Increment of each click is 10A.</p>
06	<p>Maximum discharging current</p>	<p>100A(default)</p> 	<p>Setting range is from 10A to 150A. Increment of each click is 10A.</p>

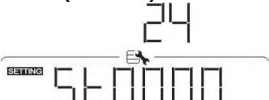
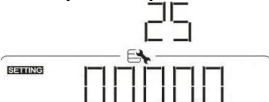





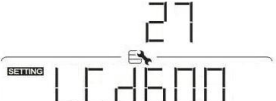
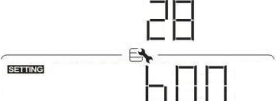
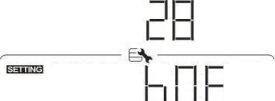
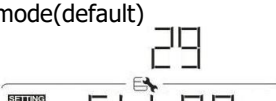

07	Bulk charging voltage (C.V voltage)	Default setting: 56.0V 	Setting range is from 48.0V to 60.0V. Increment of each click is 0.1V.
08	Floating charging voltage	Default setting: 54.0V 	Setting range is from 48.0V to 60.0V. Increment of each click is 0.1V.
09	Low DC cut off battery voltage setting when grid is available	Default setting:42.0 	Setting range is from 40V to 60V. Increment of each click is 0.1V.
10	Battery re-discharging voltage when grid is available.	Default setting:48.0 	Setting range is form 40V to 60V. Increment of each click is 0.1V
11	Low DC cut off battery voltage when grid is unavailable.	Default setting:48.0 	Setting range is from 42V to 60V voltage. Increment of each click is 0.1V
12	Battery re-discharging voltage when grid is unavailable	Default setting:54.0 	Setting range is from 42V to 60V voltage. Increment of each click is 0.1V
13	Operation Mode	Grid-tie with backup 	PV power can feed-in back to grid, provide power to the load and charge battery.
		Off-Grid 	PV power only provides power to the load and charge battery. No feed-in back to grid is allowed.
		Grid-Tie 	PV power only can feed-in back to grid.

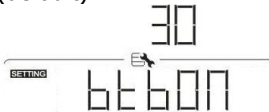
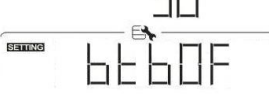
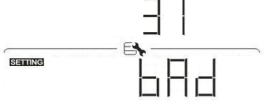
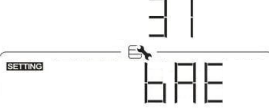
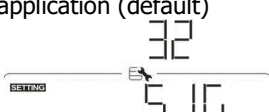
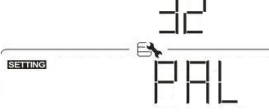
14	PV energy supply priority setting	Grid-tie with backup Mode	
		Grid-tie with backup I 	Battery-Load-Grid: PV power will charge battery first, then provide power to the load. If there is any remaining power left, it will feed-in to the grid.
		Grid-tie with backup II 	Load-Battery-Grid: PV power will provide power to the load first. Then, it will charge battery. If there is any remaining power left, it will feed-in to the grid.
		Grid-tie with backup III 	Load-Grid-Battery: PV power will provide power to the load first. If there is more PV power available, it will feed-in to the grid. If feed-in power reaches max. feed-in power setting, the remaining power will charge battery.
		Grid-tie with backup IV 	If selected, it is only allowed to set up peak time and off-peak for electricity demand. Programs of 15, 17, 18, 19 and 20 can't be set and only programs of 21, 22, 23 and 24 can be set.
		Off-Grid Mode	
		Off-Grid I 	Load-Battery: PV power will provide power to the load first and then charge battery. Feed-in to the grid is not allowed under this mode. At the same time, the grid relay is
		Off-Grid II 	Battery-Load: PV power will charge battery first. After battery is fully charged, if there is remaining PV power left, it will provide power to the load. Feed-in to the grid is not allowed under this mode. At the same time, the grid

		<p>Off-Grid III</p>	<p>relay is connected.</p> <p>Load-Battery: PV power will provide power to load first and then charge battery. Feed-in to the grid is not allowed under this mode. The grid relay is NOT connected.</p>
		<p>Grid-Tie Mode</p>	<p>PV power only feeds-in to the grid. No priority setting is available.</p>
15	Charger source priority	<p>Solar and Utility(default)</p>	<p>If there is remaining PV power after supporting the loads, it will charge battery first. Only until PV power is not available, grid will charge battery.</p>
		<p>Only Solar</p>	<p>It is only allow PV power to charge battery.</p>
		<p>None</p>	<p>It is not allowed to charge battery no matter it's PV power or grid.</p>
16	Feed to grid function	<p>Feed to grid disable (default)</p>	<p>Feed to grid enable</p>
		<p>Battery feed to grid disable (default)</p>	<p>Battery feed to grid enable</p>
17	Battery energy feed to grid function when PV energy is available	<p>Battery feed to grid disable (default)</p>	<p>Battery feed to grid enable</p>
18	Battery energy feed to grid function when PV energy is unavailable.	<p>Battery feed to grid disable (default)</p>	<p>Feed to grid enable</p>

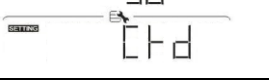
19	Load supply source (PV is available)	<p>SUB(default)</p> 	<p>Solar-grid-battery: PV power will provide power to the load first. If it's not sufficient, grid will provide power to the load. If grid is not available at the same time, battery power will back up.</p>
		<p>SBU</p> 	<p>Solar-Battery-Grid: PV power will provide power to the load first. If it's not sufficient, battery power will provide power to the load. When battery power is running out or not available, grid will back up the load.</p>
20	Load supply source (PV is unavailable)	<p>UB(default)</p> 	<p>Grid-Battery: Grid will provide power to the load at first. If grid is not available, battery power will provide power backup.</p>
		<p>BU</p> 	<p>Battery-Grid: Battery power will provide power to the load at first. If battery power is running out, grid will back up the load. This setting is ineffective during of AC charging.</p>
21	Start charging time for first duration of AC charge	<p>00:00 (Default)</p> 	<p>The setting range of start charging time for AC charger is from 00:00 to 23:00. Increment of each click is 1 hour.</p>
22	Stop charging time for first duration of AC charge	<p>00:00 (Default)</p> 	<p>The setting range of stop charging time for AC charger is from 00:00 to 23:00. Increment of each click is 1 hour.</p>
23	Start charging time for second duration of AC charge	<p>00:00 (Default)</p> 	<p>The setting range of start charging time for AC charger is from 00:00 to 23:00. Increment of each click is 1 hour.</p>

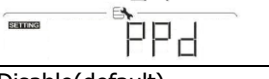
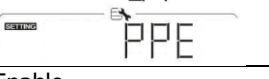
24	Stop charging time for second duration of AC charge	00:00 (Default) 	The setting range of start charging time for AC charger is from 00:00 to 23:00. Increment of each click is 1 hour.
25	Scheduled time for AC output on	00:00 (Default) 	The setting range of AC output on is from 00:00 to 23:00. Increment of each click is 1 hour.
26	Scheduled time for AC output off	00:00 (Default) 	The setting range of AC output off is from 00:00 to 23:00. Increment of each click is 1 hour.
27	LCD off waiting time	LCD is always on 	The LCD turns off after 30s 
		The LCD turns off after 60s(default) 	The LCD turns off after 300s. 
		The LCD turns off after 600s 	
28	Alarm control	Alarm on(default) 	Alarm off 
29	Alarm control at standby mode	Alarm on in standby mode(default) 	Alarm off in standby mode 

30	Alarm control at battery mode	Alarm on in battery mode (default) 	Alarm off in battery mode 
31	Activate lithium battery when the device is powered on	Activate lithium battery enable(default) 	Activate lithium battery disable 
32	AC output mode	Single: This inverter is used in single phase application (default) 	Parallel: This inverter is operated in parallel system. 
33	Generator as AC source	Disable(default) 	Enable 
34	Wide AC input range	Disable(default) 	Enable 
36	External CT function	Disable (default) 	Enable 
37	PV parallel	Disable(default) 	Enable 
38	Ac output coupling	Disable(default) 	Enable 

39	Time setting – Minute		For minute setting, the range is from 00 to 59.
40	Time setting – Hour		For hour setting, the range is from 00 to 23.
41	Time setting– Day		For day setting, the range is from 00 to 31.
42	Time setting– Month		For month setting, the range is from 01 to 12.
43	Time setting – Year		For year setting, the range is from 17 to 99.

12-5. Query Menu Operation

The display shows current contents that have been set. The displayed contents can be changed in query menu via button operation. Press 'Enter' button to enter query menu. There are seven query selections:

- Input voltage or frequency of AC input.
- Frequency, voltage, power or load percentage of AC output.
- Input voltage or power of PV input.
- Battery voltage or capability percentage.

Setting Display Procedure

- **Input voltage or frequency of AC input**

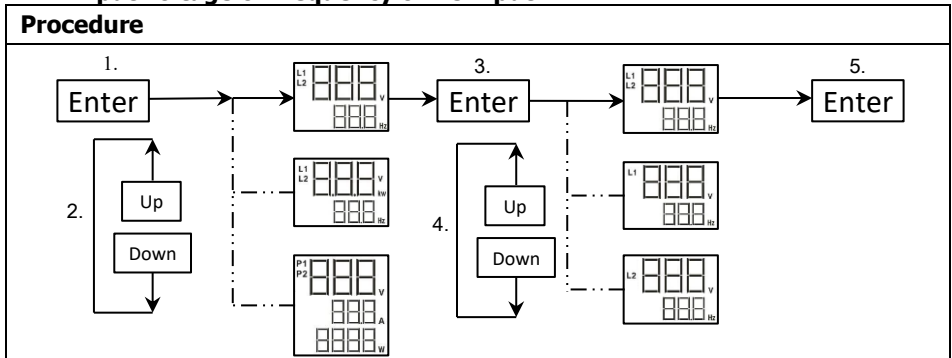

● **Frequency, voltage, power or percentage of AC output**

Procedure

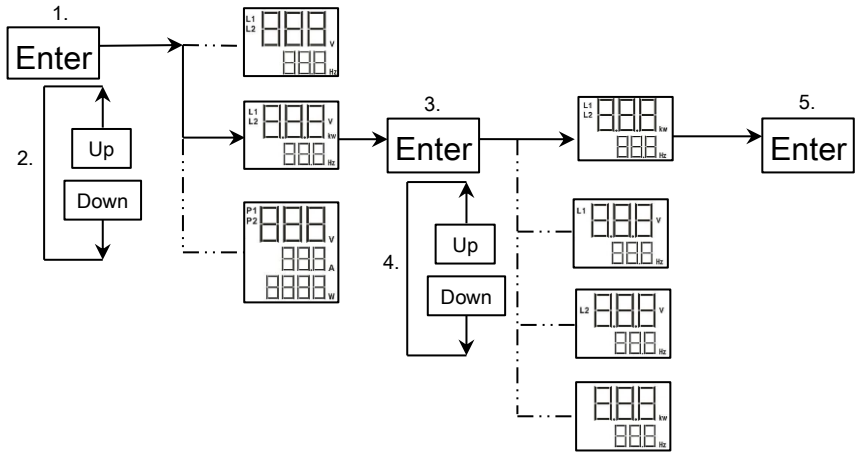

● **Input voltage or power of PV input.**

Procedure

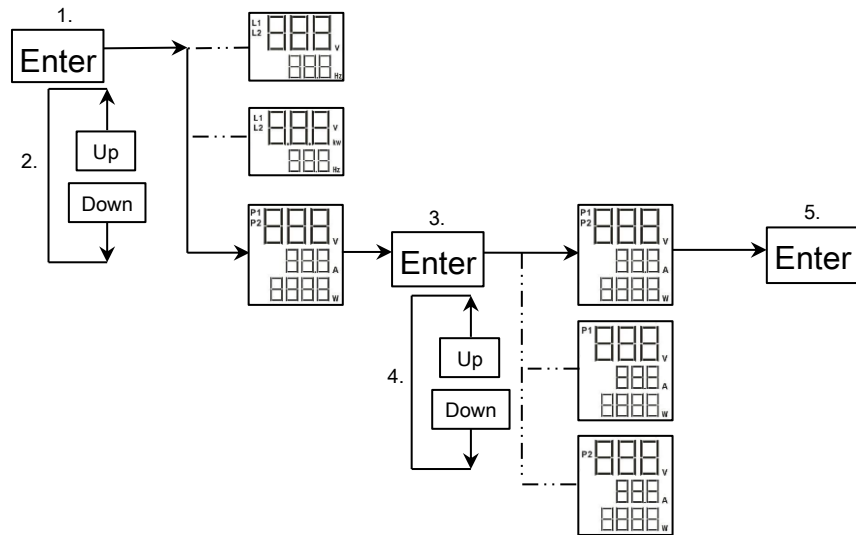

Switch LCD Displayed Information

The LCD display information will be switched in turns by pressing "▲" or "▼" key. The selectable information is switched as the following table in order.

Selectable information	LCD display
Real date	<p>Real date : 2020-08-18</p>
Real time	<p>Real time : 10:08</p>

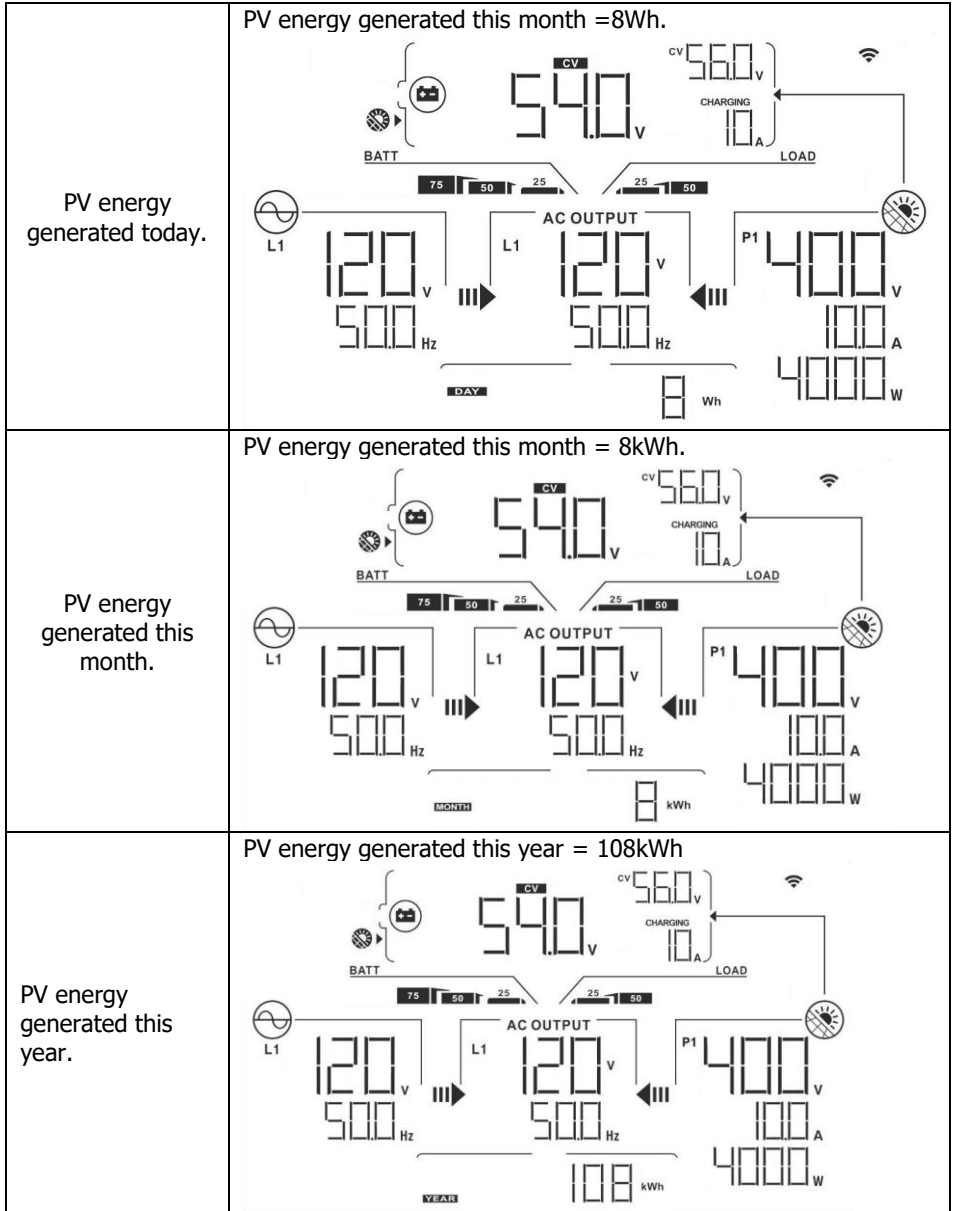

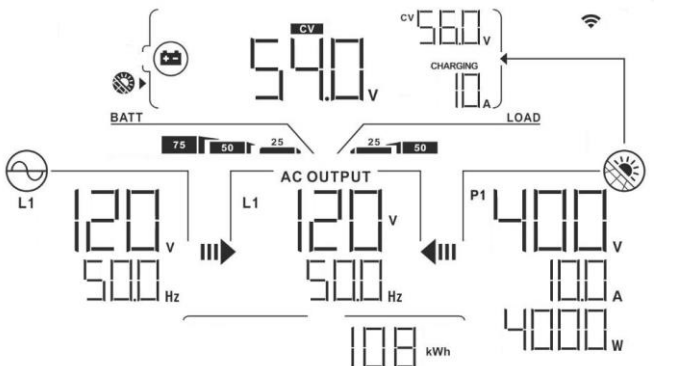
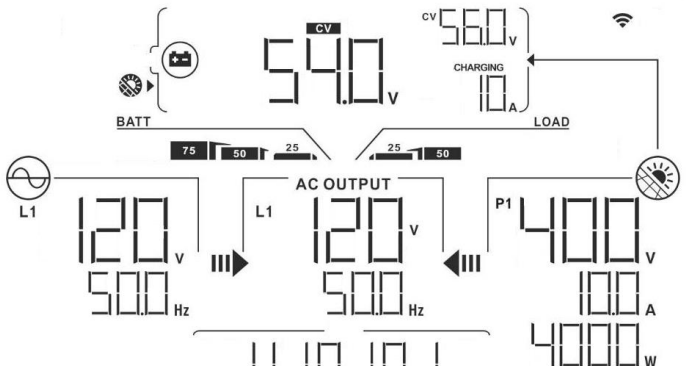
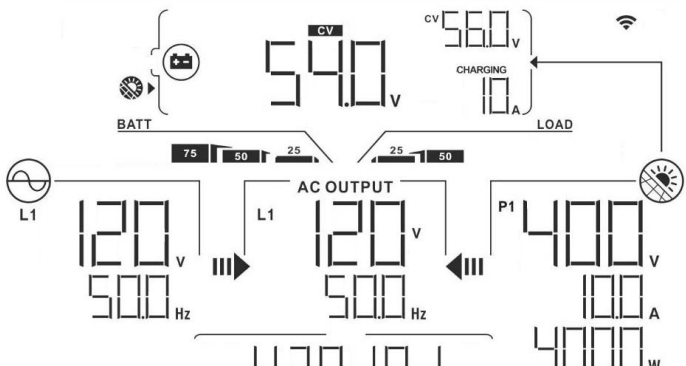
<p>PV energy generated totally.</p>	<p>Total PV energy generation = 108kWh.</p> 
<p>Main CPU version checking.</p>	<p>Main CPU version 01.01.</p> 
<p>Secondary CPU version checking.</p>	<p>Secondary CPU version 01.01.</p> 

<p>Remote panel version checking</p>	<p>Remote panel version 16.00</p>
<p>Warning code</p>	<p>Warning code : 08</p>

12-6. Operation Mode & Display

Below is only contained LCD display for **grid-tie with backup mode (I)**. If you need to know other operation mode with LCD display, please check with installer.

Inverter mode with grid connected

This inverter is connected to grid and working with DC/INV operation.

LCD Display	Description
	<p>PV power is sufficient to charge battery, provide power to loads, and then feed in to the grid.</p>

	<p>PV power is sufficient to charge the battery first. However, remaining PV power is not sufficient to back up the load. Therefore, remaining PV power and the utility are supplying power to the connected load.</p>
	<p>PV power is generated, but not sufficient enough to charge battery by itself. PV power and the utility are charging battery at the same time. And the utility is also supplying power to the connected load.</p>
	<p>This inverter is disabled to generate power to the loads via AC output. PV power is sufficient to charge battery first. Remaining PV power will feed in back to grid.</p>
	<p>This inverter is disabled to generate power to the loads via AC output. PV power and utility are charging battery at the same time because of insufficient PV power.</p>
	<p>This inverter is disabled to generate power to the loads via AC output. PV power is feeding power back to the grid.</p>

	<p>PV power is sufficient to provide power to loads and feed power back to the grid.</p>
	<p>PV power and utility are providing power to the connected loads because of insufficient PV power.</p>

Inverter mode without grid connected

This inverter is working with DC/INV operation and not connecting to the grid.

LCD Display	Description
	<p>PV power is sufficient to charge battery and provide power to the connected loads.</p>
	<p>PV power is generated, but not sufficient to power loads by itself. PV power and battery are providing power to the connected loads at the same time.</p>
	<p>Only battery power is available to provide power to connected loads.</p>

Bypass mode

The inverter is working without DC/INV operation and connecting to the loads.

LCD Display	Description
	<p>Only utility is charging battery and providing power to connected loads.</p>
	<p>Only utility is available to provide power to connected loads.</p>

Standby mode :

The inverter is working without DC/INV operation and load connected.

LCD Display	Description
	<p>This inverter is disabled on AC output or even AC power output is enabled, but an error occurs on AC output. Only PV power is sufficient to charge battery.</p>
	<p>This inverter is disabled to generate power to the loads via AC output. PV power is not detected or available at this moment. Only utility is available to charge battery.</p>
	<p>If PV, battery or utility icons are flashing, it means they are not within acceptable working range. If they are not displayed, it means they are not detected.</p>

13. Charging Management

Charging Parameter	Default Value	Note
Charging current	60A	It can be adjusted via software from 5Amp to 120Amp.
Floating charging voltage (default)	54.0 Vdc	It can be adjusted via software from 50Vac to 62Vdc.
Max. absorption charging voltage (default)	56.0 Vdc	It can be adjusted via software from 50Vac to 62Vdc.
Battery overcharge protection	64.0 Vdc	
<p>Charging process based on default setting.</p> <p>3 stages:</p> <p>First – max. charging voltage increases to 56V;</p> <p>Second- charging voltage will maintain at 56V until charging current is down to 12 Amp;</p> <p>Third- go to floating charging at 54V.</p>		

This inverter can connect to battery types of sealed lead acid battery, vented battery, gel battery and lithium battery. The detail installation and maintenance explanations of the external battery pack are provided in the manufacturer’s external battery pack of manual.

If using sealed lead acid battery, please set up the max. charging current according to below formula:

$$\text{The maximum charging current} = \text{Battery capacity (Ah)} \times 0.2$$

For example, if you are using 300 Ah battery, then, maximum charging current is $300 \times 0.2=60$ (A). Please use at least 50Ah battery because the settable minimum value of charging current is 10A. If using AGM/Gel or other types of battery, please consult with installer for the details.

Below is setting screen from software:

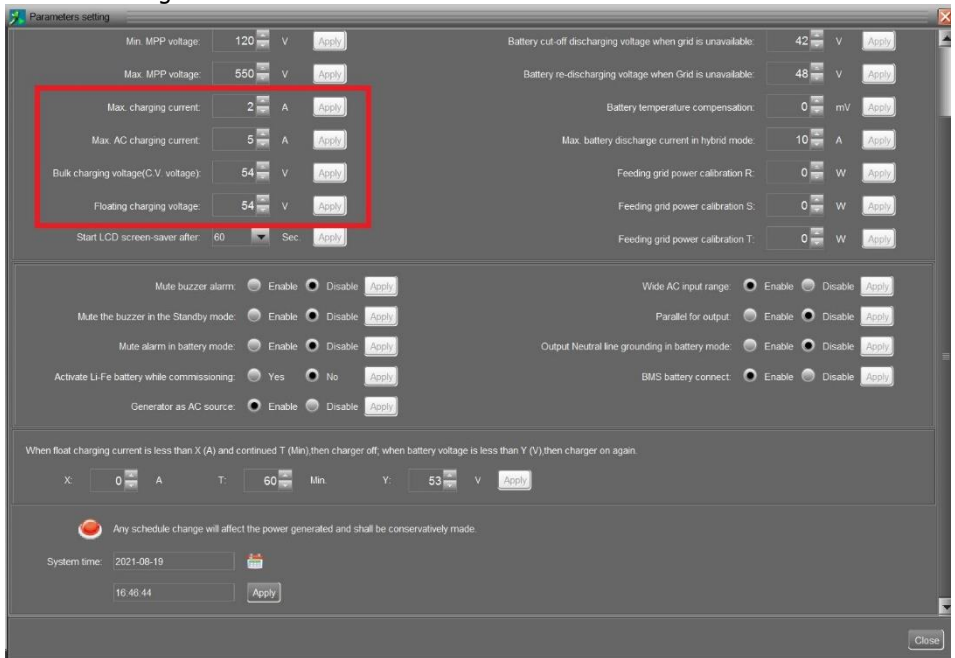

14. Maintenance & Cleaning

Check the following points to ensure proper operation of whole solar system at regular intervals.

- Ensure all connectors of this inverter are cleaned all the time.
- Before cleaning the solar panels, be sure to turn off PV DC breakers.
- Clean the solar panels, during the cool time of the day, whenever it is visibly dirty.
- Periodically inspect the system to make sure that all wires and supports are securely fastened in place.

WARNING: There are no user-replaceable parts inside of the inverter. Do not attempt to service the unit yourself.

Battery Maintenance

- Servicing of batteries should be performed or supervised by personnel knowledgeable about batteries and the required precautions.
- When replacing batteries, replace with the same type and number of batteries or battery packs.
- The following precautions should be observed when working on batteries:
 - a) Remove watches, rings, or other metal objects.
 - b) Use tools with insulated handles.
 - c) Wear rubber gloves and boots.
 - d) Do not lay tools or metal parts on top of batteries.
 - e) Disconnect charging source prior to connecting or disconnecting battery terminals.
 - f) Determine if battery is inadvertently grounded. If inadvertently grounded, remove source from ground. Contact with any part of a grounded battery can result in electrical shock. The likelihood of such shock can be reduced if such grounds are removed during installation and maintenance (applicable to equipment and remote battery supplies not having a grounded supply circuit).

CAUTION: A battery can present a risk of electrical shock and high short-circuit current.

CAUTION: Do not dispose of batteries in a fire. The batteries may explode.

CAUTION: Do not open or mutilate batteries. Released electrolyte is harmful to the skin and eyes. It may be toxic.

















15. Trouble Shooting

When there is no information displayed in the LCD, please check if PV module/battery/grid connection is correctly connected.

NOTE: The warning and fault information can be recorded by remote monitoring software.

15-1. Warning List

There are 17 situations defined as warnings. When a warning situation occurs,  icon will flash. Touch "up" or "down" to select displaying warning code. If there are several codes, it will display in sequences. Please contact your installer when you couldn't handle with the warning situations.

Code	Warning Event	Icon (flashing)	Description
01	Line voltage high loss		Grid voltage is too high.
02	Line voltage low loss		Grid voltage is too low.
03	Line frequency high loss		Grid frequency is too high.
04	Line frequency low loss		Grid frequency is too low.
05	Line voltage loss for long time		Grid voltage is higher than 253V.
06	Ground Loss		Ground wire is not detected.
07	Island detect		Island operation is detected.
08	Line waveform loss		The waveform of grid is not suitable for inverter.
09	Line phase loss		The phase of grid is not in right sequence.
10	EPO detected		EPO is open.
11	Overload		Load exceeds rating value.
12	Over temperature		The temperature is too high inside.
13	Batter voltage low		Battery discharges to low alarm point.
14	Battery under-voltage when grid is loss		Battery discharges to shutdown point.
15	Battery open		Battery is unconnected or too low.
16	Battery under-voltage when grid is OK		Battery stops discharging when the grid is OK.
17	Solar over voltage		PV voltage is too high.

15-2. Fault Reference Codes

When a fault occurs, the icon **ERROR** will flash as a reminder. See below for fault codes for reference.

Fault Code	Situation		Solution
	Fault Event	Possible cause	
01	Bus voltage over	Surge	1. Restart the inverter. 2. If the error message still remains, please contact your installer.
02	BUS voltage under	PV or battery disconnect suddenly	1. Restart the inverter 2. If the error message still remains, please contact your installer.
03	BUS soft start time out	Internal components failed.	Please contact your installer.
04	INV soft start time out	Internal components failed.	Please contact your installer.
05	INV over current	Surge	1. Restart the inverter. 2. If the error message still remains, please contact your installer.
06	Over temperature	Internal temperature is too high.	1. Check the ambient temperature and fans. 2. If the error message still remains, please contact your installer.
07	Relay fault	Internal components failed.	Please contact your installer.
08	CT sensor fault	Internal components failed.	Please contact your installer.
09	Solar input power abnormal	1. Solar input driver damaged. 2. Solar input power is too much when voltage is more than 600V.	1. Please check if solar input voltage is higher than 600V. 2. Please contact your installer.
11	Solar over current	Surge	1. Restart the inverter. 2. If the error message still remains, please contact your installer.

12	GFCI fault	Leakage current exceeds the limit.	1. Check the wire and panels which may cause the leakage. 2. If the error message still remains, please contact your installer.
13	PV ISO fault	The resistance between PV and ground is too low.	
14	INV DC current over	Utility fluctuates.	1. Restart the inverter. 2. If the error message still remains, please contact your installer.
16	GFCI sensor fault	GFCI sensor failed.	Please contact your installer.
17	DSP and MCU Com. Loss	Communication loss between DSP and MCU	Please contact your installer.
22	Battery high voltage fault	Battery voltage exceeds the limit.	1. Check the battery voltage. 2. If the error message still remains, please contact your installer.
23	Over load	The inverter is loaded with more than 110% load and time is up.	Reduced the connected load by switching off some equipment.
26	INV short	Output short circuited.	Check if wiring is connected well and remove abnormal load.
27	Fan lock	Fan failed.	Please contact your installer.
32	DC/DC over current	Battery voltage fluctuates.	1. Restart the inverter. 2. If the error message still remains, please contact your installer.
33	INV voltage low	Internal components failed.	Please contact your installer.
34	INV voltage high	Internal components failed.	Please contact your installer.
35	Wire connection fault	Internal wires loosen.	Please contact your installer.
36	OP voltage fault	Grid connects to output terminal	Don't connect the grid to the output terminal.
38	Short circuited on PV input	Short circuited on PV input	Please contact your installer.
50	Incompatible inverter firmware	Inverter hardware does not match firmware.	Please contact your installer.

16. Specifications

MODEL	BluePower IP6048
RATED POWER	6000 W
PV INPUT (DC)	
Maximum DC Power	7500 W
Nominal DC Voltage	360 VDC
Maximum DC Voltage	600 VDC
Working DC Voltage Range	120 VDC ~ 550 VDC
Start-up Voltage / Initial Feeding Voltage	125 VDC / 160 VDC
MPP Voltage Range / Full Load MPP Voltage Range	120 VDC ~ 550 VDC
Maximum Input Current	2*15 A
Isc PV (absolute maximum)	21 A
Max. inverter back feed current to the array	0 A
GRID OUTPUT (AC)	
Nominal Output Voltage	120 VAC (P-N) / 208 VAC (P-P)/ 240 VAC(P-P)
Output Voltage Range	105.5 - 132 VAC per phase
Output Frequency Range	47.5 ~ 51.5 Hz or 59.3~ 60.5Hz
Nominal Output Current	25A per phase
Inrush Current/Duration	30 A per phase / 20ms
Maximum Output Fault Current/Duration	81 A per phase / 1ms
Maximum Output Overcurrent Protection	81 A per phase
Power Factor Range	0.9 lead – 0.9 lag
AC INPUT	
AC Start-up Voltage	85 VAC per phase
Auto Restart Voltage	90 VAC per phase
Acceptable Input Voltage Range	85 - 140 VAC per phase
Nominal Frequency	50 Hz / 60 Hz
AC Input Power	6000VA/6000W
Maximum AC Input Current	40 A
Inrush Input Current	40 A / 1ms
BATTERY MODE OUTPUT (AC)	
Nominal Output Voltage	120 VAC (P-N) / 208 VAC (P-P)/ 240 VAC(P-P)
Output Frequency	50 Hz / 60 Hz (auto sensing)
Output Waveform	Pure sine wave
Output Power	6000VA/6000W
Efficiency (DC to AC)	91%
BATTERY & CHARGER (Lead-acid/Li-ion)	
DC Voltage Range	40 – 62 VDC
Nominal DC Voltage	48 VDC
Maximum Battery Discharging Current	150 A
Maximum Charging Current	120 A

GENERAL	
PHYSICAL	
Dimension, D X W X H (mm)	215.5 x 515 x 700
Net Weight (kgs)	41
INTERACE	
Communication Port	RS-232/USB
Intelligent Slot	RS232/USB,BMS, WIFI
ENVIRONMENT	
Protective Class	I
Ingress Protection Rating	IP65
Humidity	0 ~ 90% RH (No condensing)
Operating Temperature	-25 to 60°C (Power derating above 45°C)
Altitude	Max. 2000m*

* Power derating 1% every 100m when altitude is over 1000m.

Appendix I: Parallel Installation Guide

Introduction

This inverter can be used in parallel with maximum 6 units. The supported maximum output power is 36KW/36KVA.

Parallel cable

You will find the following items in the package:

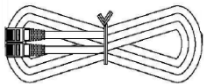

Parallel communication cable



Current sharing wires

Overview

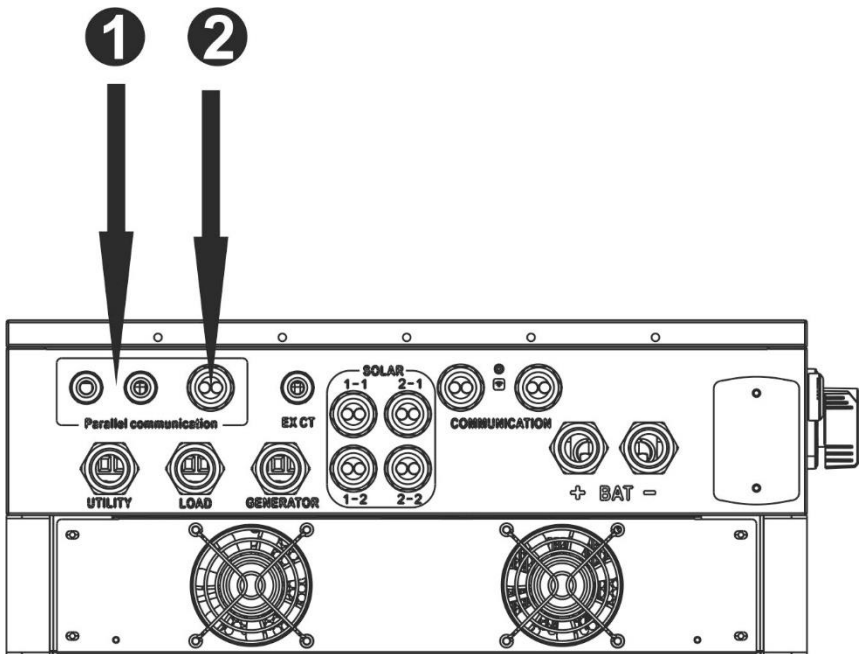

1. Current sharing port
2. Parallel communication port

Mounting the Unit

When installing multiple units, please follow below chart.

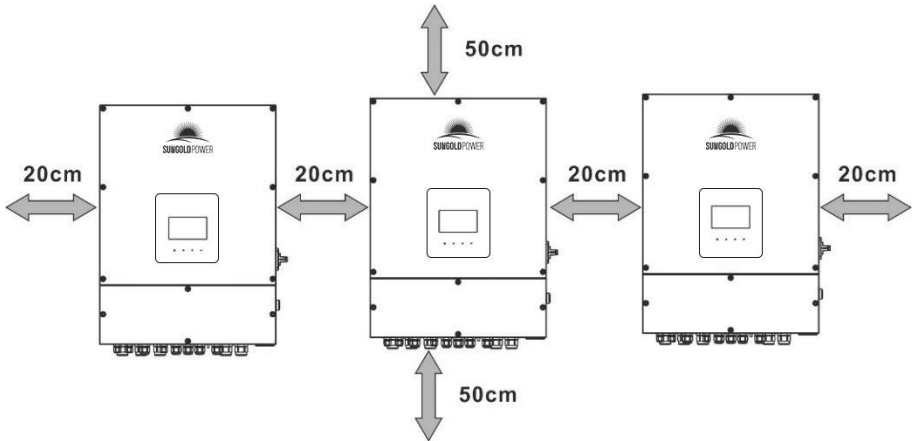

NOTE: For proper air circulation to dissipate heat, it's necessary to allow a clearance of approx. 20 cm to the side and approx. 50 cm above and below the unit. Be sure to install each unit in the same level.

Wiring Connection

The cable size of each inverter is shown as below:

Recommended battery cable and terminal size for each inverter:

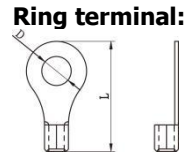

Wire Size	Ring Terminal			Torque value
	Cable mm ²	Dimensions		
		D (mm)	L (mm)	
3/0	85	8.4	54.2	7~12 Nm

WARNING: Be sure the length of all battery cables is the same. Otherwise, there will be voltage difference between inverter and battery to cause parallel inverters not working.

Recommended AC input and output cable size for each inverter:

AWG no.	Conductor cross-section	Torque
10~8 AWG	5.5~10 mm ²	1.4~1.6Nm

You need to connect the cables of each inverter together. Take the battery cables for example. You need to use a connector or bus-bar as a joint to connect the battery cables together, and then connect to the battery terminal. The cable size used from joint to battery should be X times cable size in the tables above. "X" indicates the number of

inverters connected in parallel.

Regarding cable size of AC input and output, please also follow the same principle.

CAUTION!! Please install a breaker at the battery side. This will ensure the inverter can be securely disconnected during maintenance and fully protected from overcurrent of battery.

Recommended breaker specification of battery for each inverter:

One unit*
200A/60VDC

*If you want to use only one breaker at the battery side for the whole system, the rating of the breaker should be X times current of one unit. "X" indicates the number of inverters connected in parallel.

Recommended battery capacity

Inverter parallel numbers	2	3	4	5	6
Battery Capacity	400AH	600AH	800AH	1000AH	1200AH

CAUTION! Please follow the battery charging current and voltage from battery spec to choose the suitable battery. The wrong charging parameters will reduce the battery lifecycle sharply.

Approximate back-up time table

Load (W)	Backup Time @ 48Vdc 400Ah (min)	Backup Time @ 48Vdc 600Ah (min)	Backup Time @ 48Vdc 800Ah (min)	Backup Time @ 48Vdc 1000Ah (min)	Backup Time @ 48Vdc 1200Ah (min)
12000	90	140	180	240	280
18000	60	90	120	160	180
24000	40	70	90	120	140
30000	35	55	75	90	110
36000	30	50	60	80	100

PV Connection

Please refer to user manual of single unit for PV Connection.

CAUTION: Each inverter should connect to PV modules separately.

Inverters Configuration

Two inverters in parallel:

Power Connection

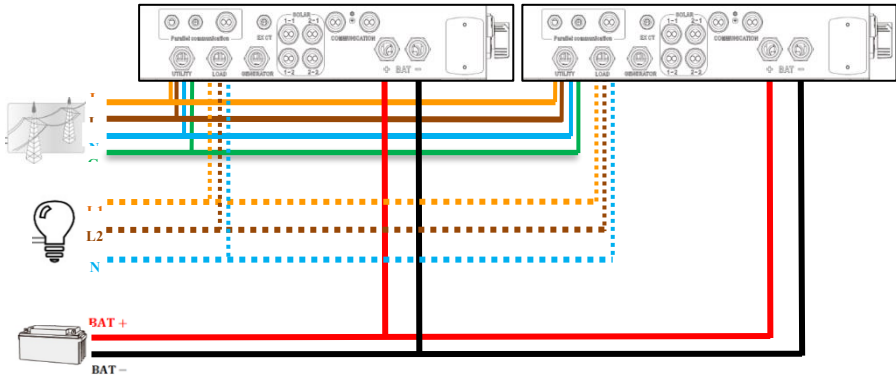

Communication Connection

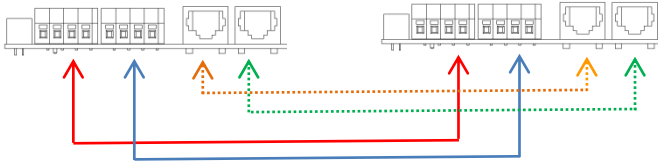

Six inverters in parallel:

Power Connection

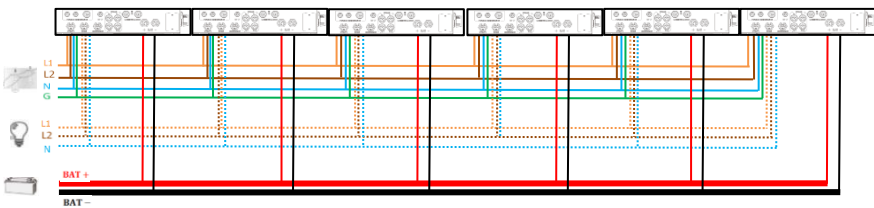

Communication Connection

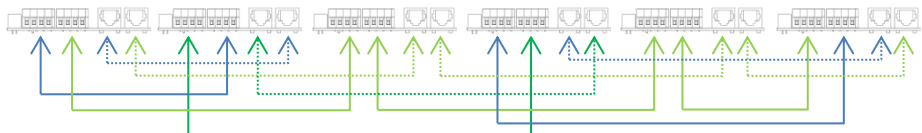

Setting and LCD Display

Setting Program:

The parallel function setting is only available by SolarPower. Please install SolarPower in your PC first.

For setting, you can set the inverter one by one through USB port.

- Use USB to synchronize the parameters:

Parallel for output: Enable/Disable

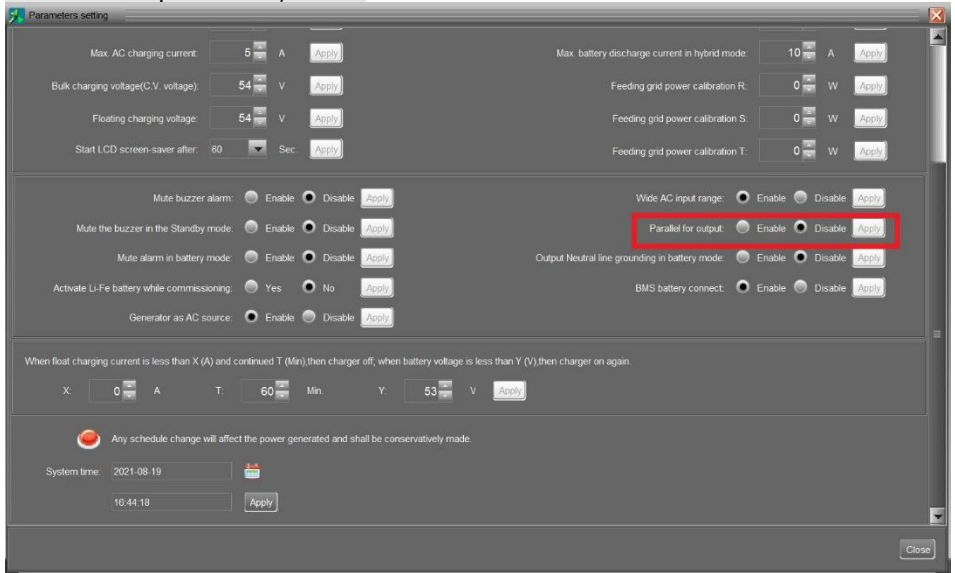

Fault code display:

Fault Code	Fault Event	Icon on
60	Power feedback protection	F60 FAULT
61	Relay board driver loss	F61 FAULT
62	Relay board communication loss	F62 FAULT
71	Firmware version inconsistent	F71 FAULT
72	Current sharing fault	F72 FAULT
80	CAN fault	F80 FAULT
81	Host loss	F81 FAULT
82	Synchronization loss	F82 FAULT

Commissioning

Step 1: Check the following requirements before commissioning:

- Correct wire connection.
- Ensure all breakers in Line wires of load side are open and each Neutral wire of each unit is connected together.

Step 2: Turn on each unit and set "enable parallel for output" on SolarPower or SolarPower Pro. And then, shut down all units.

Step 3: Turn on each unit.

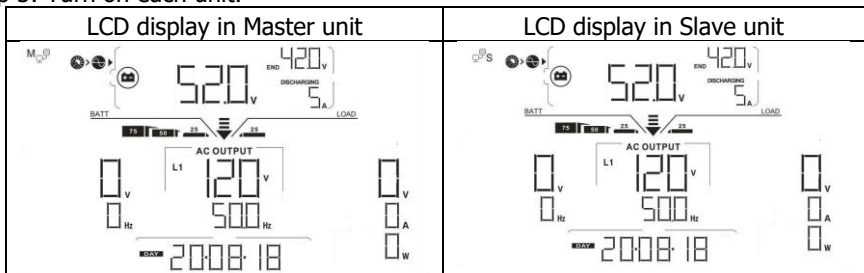

NOTE: Master and slave units are randomly defined. Warning 02 is AC GRID voltage low.

Step 4: Switch on all AC breakers of Line wires in AC input. It's better to have all inverters connect to utility at the same time. If not, it will display fault 82 in following-order inverters. However, these inverters will automatically restart. If detecting AC connection, they will work normally.

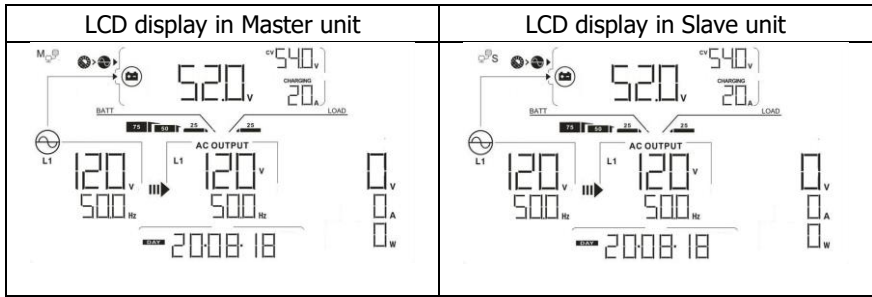

Step 5: If there is no more fault alarm, the parallel system is completely installed.

Step 6: Please switch on all breakers of Line wires in load side. This system will start to provide power to the load.

Trouble shooting

Situation		Solution
Fault Code	Fault Event Description	
60	Current feedback into the inverter is detected.	<ol style="list-style-type: none"> Restart the inverter. Check if L1/L2/N cables are not connected with wrong sequence in all inverters. Make sure the sharing cables are connected in all inverters. If the problem remains, please contact your installer.
61	Relay board driver loss	<ol style="list-style-type: none"> Disconnect all of power source. Only connect AC input and press Enter key to let it working in bypass mode. Check if the problem happens again or not and feed back the result to your installer.
62	Relay board communication loss	
71	The firmware version of each inverter is not the same.	<ol style="list-style-type: none"> Update all inverter firmware to the same version. After updating, if the problem still remains, please contact your installer.
72	The output current of each inverter is different.	<ol style="list-style-type: none"> Check if sharing cables are connected well and restart the inverter. If the problem remains, please contact your installer.
80	CAN data loss	<ol style="list-style-type: none"> Check if communication cables are connected well and restart the inverter. If the problem remains, please contact your installer.
81	Host data loss	
82	Synchronization data loss	

Appendix II: The Wi-Fi Operation Guide

1. Introduction

Wi-Fi module can enable wireless communication between hybrid inverters and monitoring platform. Users have complete and remote monitoring and controlling experience for inverters when combining Wi-Fi module with SolarPower APP, available for both iOS and Android based device. All data loggers and parameters are saved in iCloud. The major functions of this APP:

- Delivers device status during normal operation.
- Allows to configure device setting after installation.
- Notifies users when a warning or alarm occurs.
- Allows users to query inverter history data.

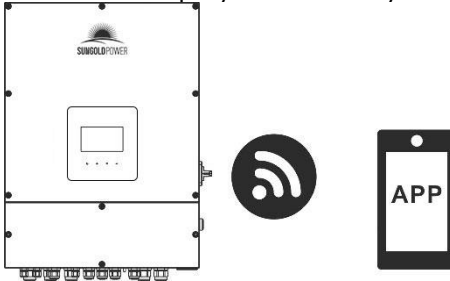

2. SolarPower App

2-1. Download and install APP

Operating system requirement for your smart phone:

🍏 iOS system supports iOS 9.0 and above

🤖 Android system supports Android 5.0 and above

Please scan the following QR code with your smart phone and download SolarPower App.



Android system



iOS system

Or you may find "SolarPower Wi-Fi" app from the Apple® Store or "SolarPower" in Google® Play Store.



2-2. Initial Setup

Step 1: Registration at first time

After the installation, please tap the shortcut icon  to access the APP on your mobile

screen. In the screen, tap "Register" to access "User Registration" page. Fill out all required information accordingly. You can scan the Wi-Fi Module PN by tapping icon . Tap "Register" after you have completed the registration.

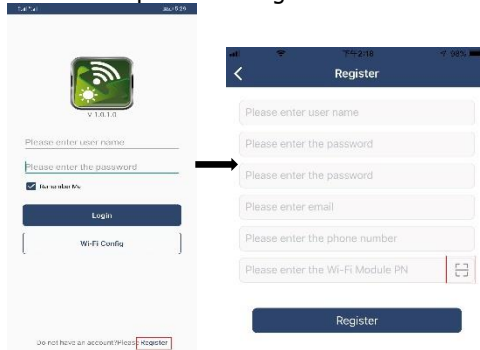

Then, a "Registration success" window will pop up. Tap "Go now" to continue setting local Wi-Fi network connection.

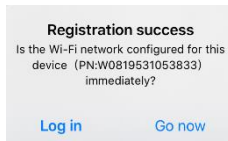

Step 2: Local Wi-Fi Module Configuration

Now, you are in "Wi-Fi Config" page. There are detailed setup procedure listed in "How to connect?" section and you may follow it to connect Wi-Fi.



1. Connect The Wi-Fi Module 2. Network Settings 3. Confirm The Wi-Fi Module Configuration 4. Successful

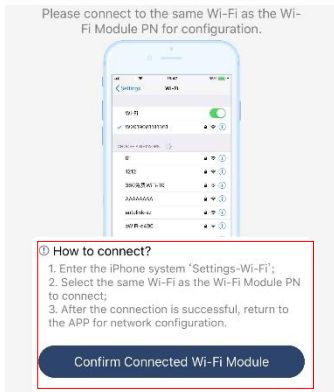

Enter the "Settings→Wi-Fi" and select connected Wi-Fi name. The connected Wi-Fi name is the same to your Wi-Fi PN number and enter default password "12345678".

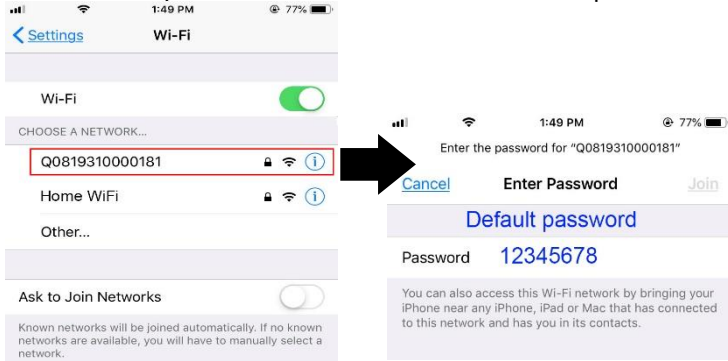

Then, return to WatchPower APP and tap " **Confirm Connected Wi-Fi Module** " button when Wi-Fi module is connected successfully.

Step 3: Wi-Fi Network settings

Tap  icon to select your local Wi-Fi router name (to access the internet) and enter password.

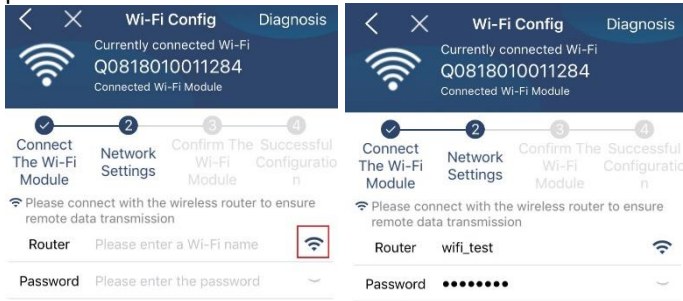

Step 4: Tap "Confirm" to complete the Wi-Fi configuration between the Wi-Fi module and the Internet.

Connect The Wi-Fi Module Network Settings **3 Confirm The Wi-Fi Module** 4 Successful Configuration

Connect The Wi-Fi Module Network Settings Confirm The Wi-Fi Module **4 Successful Configuration**

Please confirm whether the currently connected Wi-Fi is the desired Wi-Fi Module (Wi-Fi is consistent with the Wi-Fi Module PN)
 Yes, please click the confirmation button below;
 No, please reconnect from the system Wi-Fi again.

Wi-Fi configuration is successful

Confirm Successful Configuration View Network Diagnostics

If the connection fails, please repeat Step 2 and 3.

Connect The Wi-Fi Module Network Settings **3 Confirm The Wi-Fi Module** 4 Successful Configuration

Please confirm whether the currently connected Wi-Fi is the desired Wi-Fi Module (Wi-Fi is consistent with the Wi-Fi Module PN)
 Yes, please click the confirmation button below;
 No, please reconnect from the system Wi-Fi again.

Your phone is not currently connected to the datalogger Wi-Fi, please connect and try again!

Confirm

Connect The Wi-Fi Module Network Settings **3 Confirm The Wi-Fi Module** 4 Successful Configuration

Please confirm whether the currently connected Wi-Fi is the desired Wi-Fi Module (Wi-Fi is consistent with the Wi-Fi Module PN)
 Yes, please click the confirmation button below;
 No, please reconnect from the system Wi-Fi again.

Your phone is not currently connected to the datalogger Wi-Fi, please connect and try again!

Diagnose Function

If the module is not monitoring properly, please tap "Diagnosis" on the top right corner of the screen for further details. It will show repair suggestion. Please follow it to fix the

problem. Then, repeat the steps in the chapter 4.2 to re-set network setting. After all setting, tap "Rediagnosis" to re-connect again.



The Inverter and the datalogger communicate abnormally.

- Please check if the Inverter and the datalogger are powered on normally.
- Please check if the Inverter address is between 1 and 5.
- Please check if the connection between the Inverter and the collector is abnormal, such as poor contact caused by oxidation or looseness of the interface, reverse connection of the 485 interface AB line, and data line damage.
- Try restarting the Inverter and datalogger to see if the anomaly is eliminated.

The diagnosis is successful!

Datalogger and router communication abnormalities

- Please confirm that the wireless routing network setting has been made.
- Make sure that the datalogger is set up to connect to AP hotspots sent by hardware devices such as wireless routers instead of virtual AP hotspots.

2-3. Login and APP Main Function

After finishing the registration and local Wi-Fi configuration, enter registered name and password to login.

Note: Tick "Remember Me" for your login convenience afterwards.



Overview

After login is successfully, you can access "Overview" page to have overview of your monitoring devices, including overall operation situation and Energy information for Current power and Today power as below diagram.

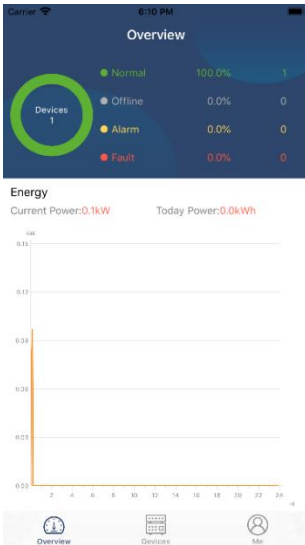

Devices

Tap the  icon (located on the bottom) to enter Device List page. You can review all devices here by adding or deleting Wi-Fi Module in this page.

Add device

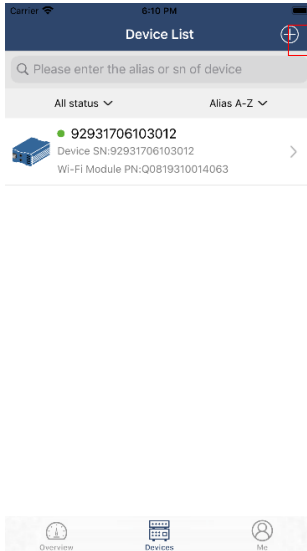

Delete device

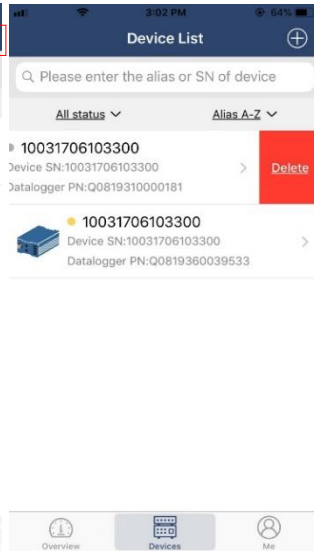

Tap  icon on the top right corner and enter part number by scanning bar code to add Wi-Fi module. This part number is printed on the Wi-Fi module's surface, or manually enter it. Tap "Confirm" to add Wi-Fi module in the Device list. Time zone and Wi-Fi module PN are required information. Tap "Confirm" to complete and the added Wi-Fi module can be reviewed in the Device list.

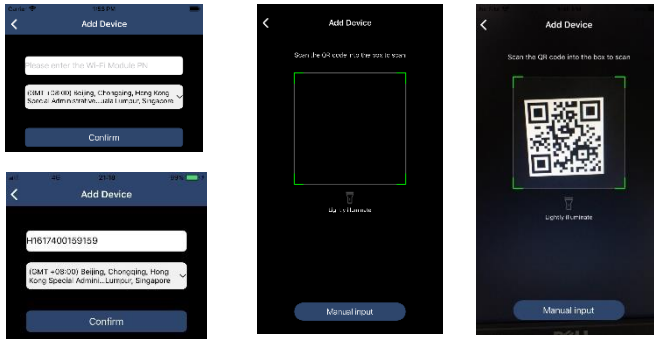

For more information about Device List, please refer to the section 2.4.

ME

In ME page, users can modify “My information”, including 【User’s Photo】 , 【Account security】 , 【Modify password】 , 【Clear cache】 ,and 【Log-out】 , shown as below diagrams.

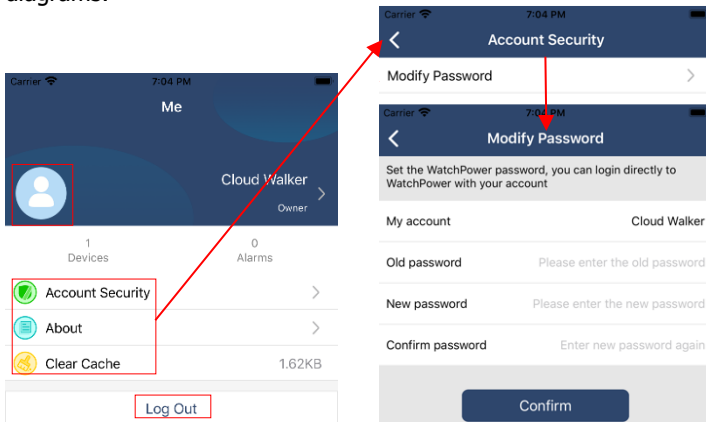

2-4. Device List

In Device List page, you can pull down to refresh the device information and then tap any device you want to check up for its real-time status and related information as well as to change parameter settings. Please refer to the parameter setting list.

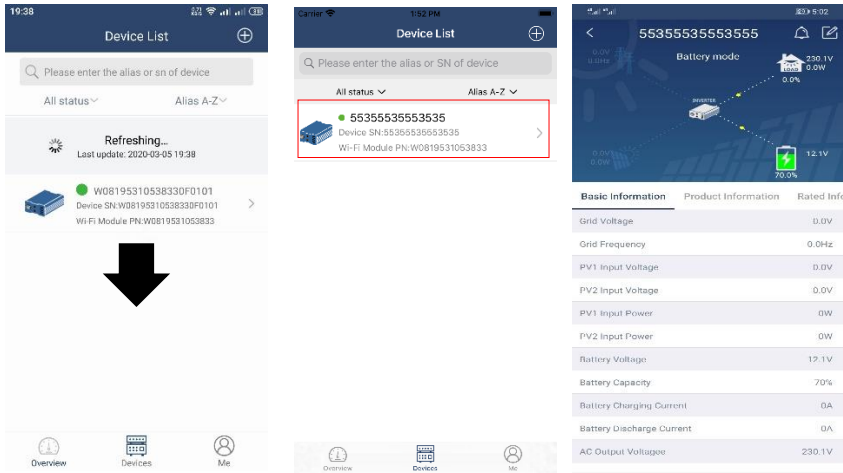

Device Mode

On the top of screen, there is a dynamic power flow chart to show live operation. It contains five icons to present PV power, inverter, load, utility and battery. Based on your inverter model status, there will be **【Standby Mode】** , **【Line Mode】** , **【Battery Mode】** .

【Standby Mode】 Inverter will not power the load until “ON” switch is pressed. Qualified utility or PV source can charge battery in standby mode.

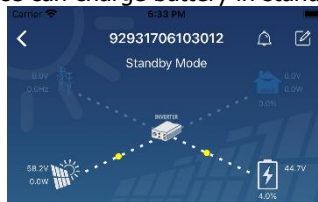

【Line Mode】 Inverter will power the load from the utility with or without PV charging. Qualified utility or PV source can charge battery.



【Battery Mode】 Inverter will power the load from the batter with or without PV charging. Only PV source can charge battery.



Device Alarm and Name Modification

In this page, tap the  icon on the top right corner to enter the device alarm page.

Then, you can review alarm history and detailed information. Tap the  icon on the top right corner, a blank input box will pop out. Then, you can edit the name for your device and tap "Confirm" to complete name modification.

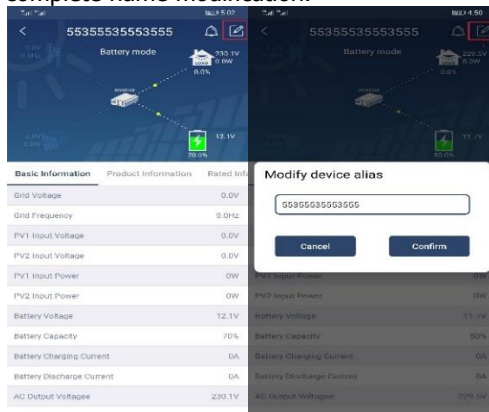

Device Information Data

Users can check up **【Basic Information】**, **【Product Information】**, **【Rated information】**, **【History】**, and **【Wi-Fi Module Information】** by swiping left.



【Basic Information】 displays basic information of the inverter, including AC voltage, AC frequency, PV input voltage, Battery voltage, Battery capacity, Charging current, Discharging current, Output voltage, Output frequency, Output apparent power, Output active power and Load percent. Please slide up to see more basic information.

【Production Information】 displays Model type (Inverter type), Main CPU version, Bluetooth CPU version and secondary CPU version.

【Rated Information】 displays information of Nominal AC voltage, Nominal AC current, Rated battery voltage, Nominal output voltage, Nominal output frequency, Nominal output current, Nominal output apparent power and Nominal output active power. Please slide up to see more rated information.

【History】 displays the records of unit information and setting.

【Wi-Fi Module Information】 displays of Wi-Fi Module PN, status and firmware version.

Parameter Setting

This page is to activate some features and set up parameters for inverters. Please be noted that the listing in "Parameter Setting" page in below diagram may differ from the models of monitored inverter. Here will briefly highlight some of it, **【Output Setting】**, **【Battery Parameter Setting】**, **【Enable/ Disable items】**, **【Restore to the defaults】** to illustrate.

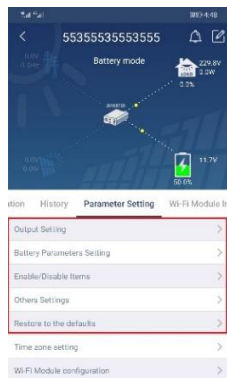

There are three ways to modify setting and they vary according to each parameter.

- Listing options to change values by tapping one of it.
- Activate/Shut down functions by clicking "Enable" or "Disable" button.
- Changing values by clicking arrows or entering the numbers directly in the column.

Each function setting is saved by clicking "Set" button.

Please refer to below parameter setting list for an overall description and be noted that the available parameters may vary depending on different models. Please always see the original product manual for detailed setting instructions.

Parameter setting list:

Item	Description	
Output Setting	Output Source Priority	Output source priority selection
	Input Voltage Range	Input voltage range selection
	AC Output Rating Voltage	To set output rating voltage
	AC Output Rating Frequency	To set output rating frequency
Battery Parameters Setting	Battery Type	Select connected battery type
	Battery Cut-off Voltage	Set battery cut-off voltage
	Bulk Charging Voltage	Set battery bulk charging voltage
	Battery Float Voltage	Set battery floating charging voltage
	Max Charging Current	To configure total charging current for solar and utility chargers.
	Max AC Charging Current	Set maximum utility charging current
	Charging Source Priority	To configure charger source priority
	Back To Grid Voltage	Set battery voltage to stop discharging when grid is available
	Back To Discharge Voltage	Set battery voltage to stop charging when grid is available
Enable/Disable Items	Overload Auto Restart	If disabled, the unit won't be restarted after overload occurs.
	Overload Temperature Auto Restart	If disabled, the unit won't be restarted after over-temperature fault is solved.
	Overload Bypass	If enabled, the unit will enter bypass mode when overload occurs.
	Beeps While Primary Source Interrupt	If enabled, buzzer will alarm when primary source is abnormal.
	Buzzer	If disabled, buzzer won't be on when alarm/fault occurred.
	Backlight	If disabled, LCD backlight will be off when panel button is not operated for 1 minute.
	LCD Screen Return To Default Display	If selected, no matter how users switch display screen, it will automatically return to default display screen (Input voltage /output voltage) after no button is pressed for 1 minute.
Fault Code Record	If enabled, fault code will be recorded in the inverter when any fault happens.	

Item		Description
Others Settings	Solar Supply Priority	Set solar power as priority to charge the battery or to power the load.
	Reset PV Energy Storage	If clicked, PV energy storage data will be reset.
	Start Time For Enable AC Charge Working	The setting range of start charging time for AC charger is from 00:00 to 23:00. The increment of each click is 1 hour.
	Ending Time For Enable AC Charge Working	The setting range of stop charging time for AC charger is from 00:00 to 23:00. The increment of each click is 1 hour.
	Scheduled Time For AC Output On	The setting range of scheduled time for AC output on is from 00:00 to 23:00. The increment of each click is 1 hour.
	Scheduled Time For AC Output Off	The setting range of scheduled time for AC output off is from 00:00 to 23:00. The increment of each click is 1 hour.
	Country Customized Regulations	Select inverter installed area to meet local regulation.
	Set Date Time	Set date time.
Restore to the defaults	This function is to restore all settings back to default settings.	